



DataVU 5 - Operating Manual

59480/1

Visualization

ENTER Representation of measurement data

Event list

ENTER Display of events

Parameterization

- ENTER Contrast
- ▲ Speed mode
- ▼ Display off
- Diagram view
- Reset counter / integrator

CompactFlash card

- ENTER CF card → Config. data
- ▲ Config. data → CF card
- ▼ Total meas. data → CF card
- Update CF card incl. counter
- Update CF card

Configuration

- ENTER Instrument (device) data
- Analog inputs
- Math channels
- Counter / integrator
- ▲ Recording
- ▼ Outputs
- Control functions
- Texts
- Interface
- Undoc. parameters
- Fine calibration

Instrument (device) info

- ENTER Version number
 - VdN number
 - Serial number
 - Input card 1
 - Input card 2
 - Digital-I/O option
 - Math option
 - Counter / integrator option
 - Error
 - Power off
 - Power on
-

1	Introduction	7
1.1	Preface	7
1.2	Arrangement of the documentation	8
1.2.1	Structure of this operating manual	8
1.3	Typographical conventions	9
1.3.1	Warning signs	9
1.3.2	Note signs	9
1.3.3	Representation modes	10
2	Device description	11
2.1	Displays and controls	11
2.2	Operating principle and graphic elements	12
2.3	Analog inputs	14
2.4	Digital signals (event traces)	15
2.5	Counters / integrators / operating time counter	16
2.5.1	Reporting period of the counts	18
2.5.2	Resetting the counters / integrators / operating time counters	18
2.5.3	Response to instrument reconfiguration	19
2.5.4	Response at end of summer time	20
2.6	Math/logic module	20
2.7	Operating modes	23
2.8	Storing data	24
2.9	Read-out of data	27
2.10	Evaluating data	27
2.11	Webserver	28
3	Operation and visualization	31
3.1	Basic menu	32

Contents

3.2	Visualization	33
3.2.1	Diagram representation with digital display (small measurements)	34
3.2.2	Diagram representation with scaling	35
3.2.3	Diagram representation with bar graph	35
3.2.4	Large digital display (large measurements)	36
3.2.5	Curve representation (header switched off)	37
3.2.6	Evaluation of the stored measurement data	38
3.2.7	Counters / integrators / operating time	41
3.3	Parameterization	43
3.4	Configuration	46
3.5	Event list	47
3.6	CompactFlash card	50
3.7	Device info	53
3.8	Text entry	55
3.9	Entering values	56
3.10	Code number (password query)	57
4	Configuration parameters	59
4.1	Operating example	59
4.2	Table of configuration parameters	60
4.2.1	Parameterization	60
4.2.2	Configuration - Instrument (device) data	62
4.2.3	Configuration - Analog inputs	64
4.2.4	Configuration - Math channels	66
4.2.5	Configuration - Counter/integrator (extra code)	66
4.2.6	Configuration - Recording	70
4.2.7	Configuration - Outputs (extra code)	73
4.2.8	Configuration - Control functions	74
4.2.9	Configuration - Texts	74
4.2.10	Configuration - Interfaces	75
4.2.11	Configuration - Undocumented parameters	76
4.2.12	Configuration - Fine calibration	76
5	Setup program	77
5.1	Hardware and software requirements	77
5.2	Installation	78

Contents

5.3	User interface	79
5.4	Configuration	81
5.5	Teleservice	84
5.6	Data transfer from and to the instrument	86
5.6.1	Transfer via CompactFlash memory card	86
5.6.2	Transfer via interface	89
5.7	Connection between the PC and the recorder	91
5.7.1	Assistant for device settings	91
5.7.2	Device list	95
5.8	Menu functions	96
5.8.1	File	96
5.8.2	Edit	97
5.8.3	Data transfer	98
5.8.4	Extras	98
5.8.5	Window	103
5.8.6	Info	104
5.9	Math/logic	105
5.10	Character set	109
6	Rights	111
6.1	Rights with regard to the setup program	111
7	PC programs	113
7.1	PC evaluation software (PCA3000)	113
7.2	PCA communication software (PCC)	114
8	Identifying the instrument version	115
8.1	Type designation	115
8.2	Standard accessories	116
8.3	Optional accessories	116
9	Installation	117
9.1	Installation site and climatic conditions	117
9.2	Fitting	117

Contents

10	Electrical connection	121
10.1	Installation notes	121
10.2	Technical data	121
10.3	Connection diagram	122
11	Index	125

1.1 Preface



Please read these operating instructions before commissioning the instrument. Keep the operating instructions in a place that is accessible to all users at all times.

Please assist us to improve these operating instructions, where necessary.

Your comments will be appreciated.



All necessary settings are described in this manual. If any difficulties should arise during commissioning, you are asked not to carry out any manipulations that could endanger your rights under the instrument warranty!

Please contact the nearest subsidiary or the head office in such a case.



When returning modules, assemblies or components, the regulations of EN 61340-5-1 and EN 61340-5-2 “Protection of electronic devices from electrostatic phenomena” must be observed. Use only the appropriate **ESD** packaging for transport.

Please note that we cannot accept any liability for damage caused by ESD.

ESD=electrostatic discharge

1 Introduction

1.2 Arrangement of the documentation

The documentation for this instrument consists of the following parts:

**Operating
Manual
59480**

This operating manual comes with the delivery. It is addressed to the equipment manufacturer and the user with appropriate technical expertise.

In addition to installation and electrical connection, it contains information on commissioning, operation and parameter setting on the instrument, as well as on the optional PC setup program and the optional evaluation program (PCA).

**Interface
Description
59482**

It provides information on the serial interface (RS232 and RS485), which can be supplied as an extra code. The interface description can be used to develop specific programs which can, for instance, read out current measurement data.

1.2.1 Structure of this operating manual

This manual is arranged in a way which permits the user to enter directly into operation and configuration of the instrument. Consequently, chapters dealing with items that normally arise only once are placed at the end of the manual. These include instrument description, type designation, installation and electrical connection.

1.3 Typographical conventions

1.3.1 Warning signs

The signs for **Danger** and **Caution** are used in this manual under the following conditions:



Danger

This symbol is used when there may be **danger to personnel** if the instructions are ignored or not followed correctly!



Caution

This symbol is used when there may be **damage to equipment or data** if the instructions are ignored or not followed correctly!



Caution

This symbol is used where special care is required when handling **components liable to damage through electrostatic discharge**.

1.3.2 Note signs



Note

This symbol is used when your **special attention** is drawn to a remark.



Reference

This symbol refers to **further information** in other manuals, chapters or sections.

abc¹

Footnote

Footnotes are remarks that **refer to specific points** in the text. Footnotes consist of two parts:

A marker in the text, and the footnote text.

The markers in the text are arranged as continuous superscript numbers.

Action instruction

*

This symbol indicates that an **action to be performed** is described.

The individual steps are marked by this asterisk, e.g.

* Press the  key

* Confirm with 

1 Introduction

1.3.3 Representation modes

Keys

 + 

Keys are **shown in a box**. Both **symbols and text** are possible. If a key has a multiple function, then the text shown is the one that corresponds to the function **that is active at the moment**.

Screen texts

*Program
Manager*

Texts that are displayed in the setup program are indicated by **italic script**.

Menu items

*Edit →
Device data*

Menu items in the setup program which are referred to in this manual are shown in italics. Menu name, menu item and submenu item are separated from each other by “→”.

2.1 Displays and controls

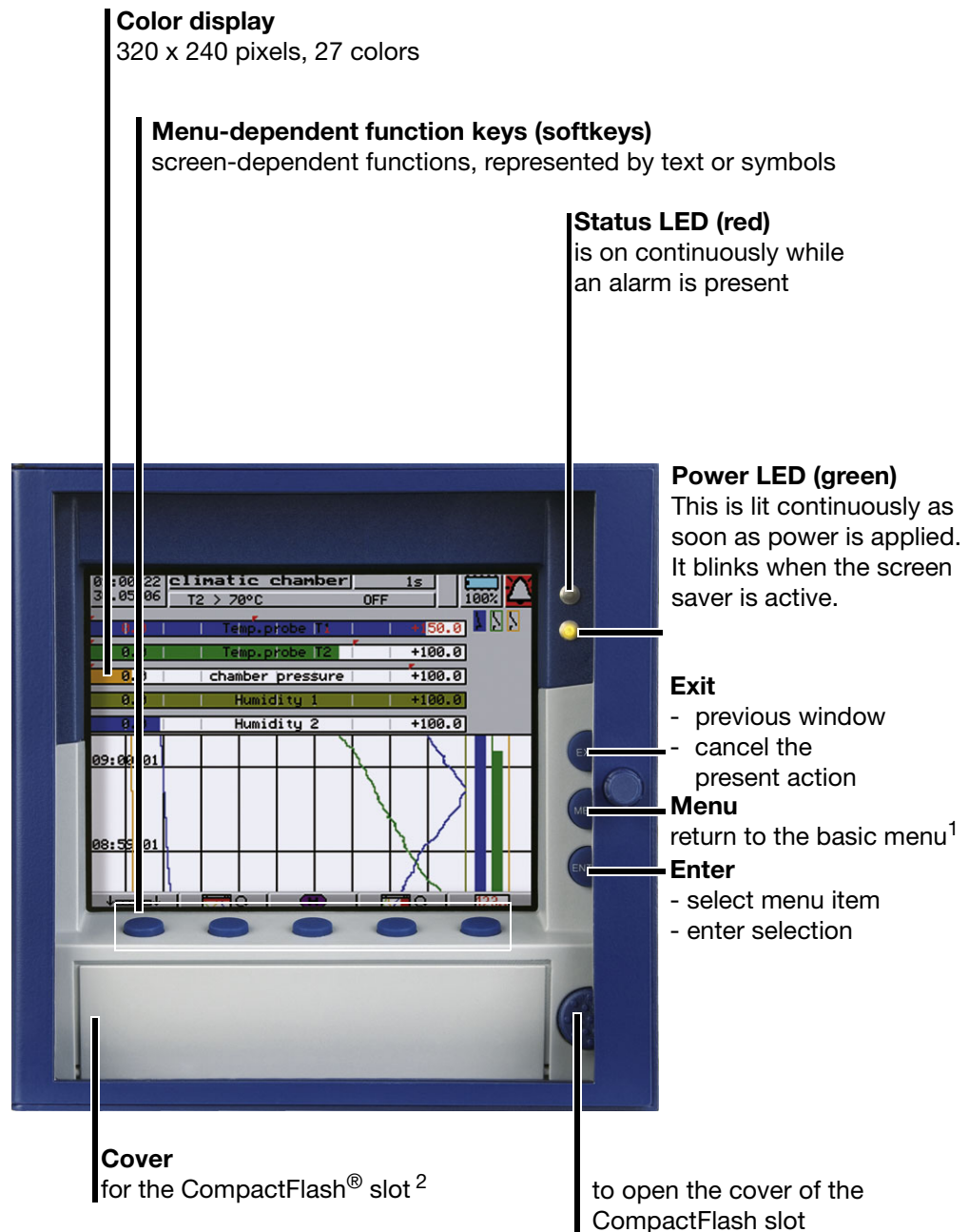

¹ Not from the configuration level if a parameter has already been modified there.
² CompactFlash[®] is a registered trademark of the SanDisk Corporation.



The life of the background illumination can be prolonged by making use of the screen saver.

⇒ Chapter 4 “Configuration parameters”,
Parameterization → *Display off*

2 Device description

Opening and closing the door of the instrument

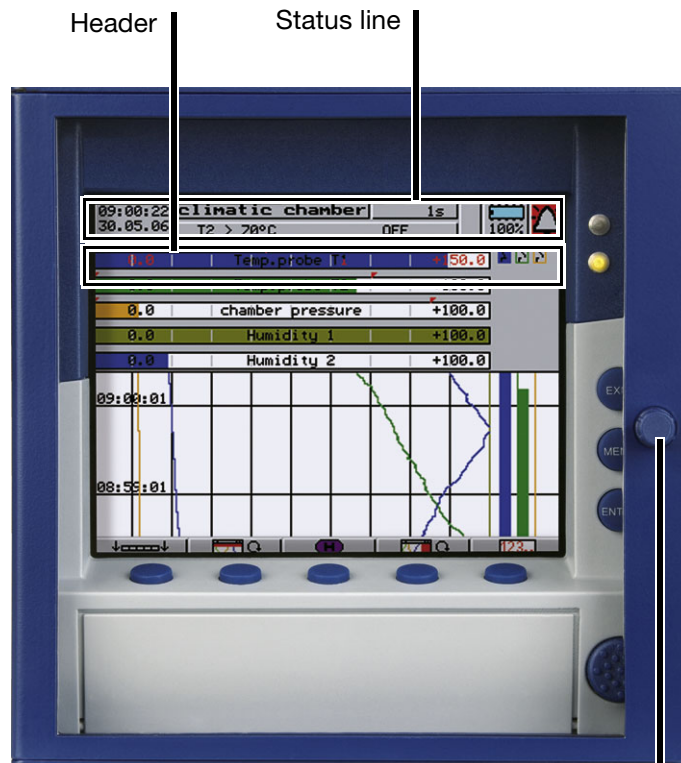

To open or close the door of the instrument, turn the knob

2.2 Operating principle and graphic elements

Keys The recorder is operated from eight keys. Three of these keys have fixed functions, the other five (softkeys) have menu-dependent functions.

⇒ Chapter 2.1 "Displays and controls"

Softkeys The functions of the softkeys appear in the bottom line of the display, as symbols or in plain text.



2 Device description

Status line

The status line is shown in the top section of the display. It provides information on important actions and states. The status line is always visible, irrespective of the level (operation, parameters, configuration).

Alarm

If an alarm occurs (e.g. out-of-limit), the bell (alarm) will flash in this field.

CF card / internal memory

Shows the free storage of the CompactFlash card or the internal memory, as a percentage. In the event of a “memory alarm” or a fault on the CF card, the field is shown with a yellow background and the symbol will flash. The error message can be checked in the CF card menu (Chapter 3.6 “CompactFlash card”).

Storage capacity of the CF card 

Available internal memory for read-out via CF card (the diagram shows a turquoise-colored memory chip) 

Available internal memory (for read-out via interface) (the diagram shows a dark blue memory chip) 

 The egg timer appears whenever the instrument cannot be operated because it is busy.

 The “H” indicates that the measurements which are displayed are derived from the past (history). The display shows the data saved in the FLASH memory.

 If a fault occurs, an “i” will flash in this position. In the device info window (⇒ Chapter 3.7 “Device info”) you can ask for the cause of the fault.

 If the keys are inhibited, a key will flash in this position.

Time & Date

Display of the current time and date

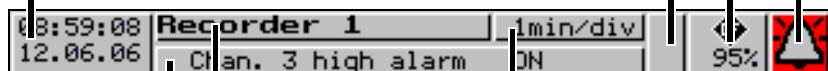

Present diagram speed
Background color:
gray = normal operation,
blue = timed operation,
orange = event operation

Instrument name (maximum 16 characters).

Shows the last entry in the event list

2 Device description

Channel line (channel representation) The channel line shows the measurements of the active channels and their unit as

- a measurement
- scale or
- bar graph.

Alternatively, the header can be switched off altogether.

In addition, alarms and out-of-limit conditions are made directly visible, depending on the display mode.

Example: Measurement (small meas.)

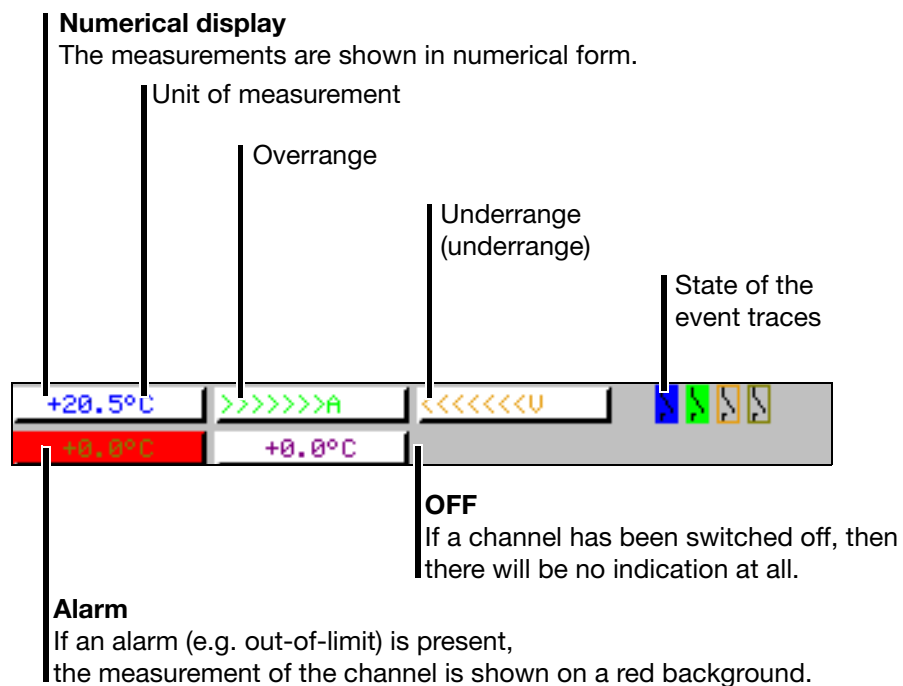

Selection and visual presentation of the channel line can be controlled through the parameter *Parameterization* → *Diagram view* → *Channel represent.* or by using the  key.

With the help of the parameter *Parameterization* → *Diagram view* → *Channel indication* → *Channel 1 – 6*, it is possible to suppress the display of individual channels in the channel line. This is especially useful for scale or bar graph display, where more space is needed to show the diagram. The channels that have been suppressed in the display will nevertheless be recorded, and shown on the diagram.

2.3 Analog inputs

Internal analog inputs The paperless recorder can be equipped with 3 or 6 analog inputs. When configuring the analog inputs (Chapter 4.2 “Table of configuration parameters”), these are designated as **analog input 1 – 3 (1 – 6)**.

2.4 Digital signals (event traces)

Signal types



In addition to the four binary inputs (extra code), digital signals generated by the instrument itself can also be displayed in the six digital traces (event traces):

signal	Description
Binary input 1 – 4	Four binary inputs available as hardware (extra code)
Logic channel 1 – 6	Channels which are created by using the math and logic module (extra code required)
Low alarm 1 – 6	Underrange of the channels
Low combination alarm	OR linkage of all low alarms
High alarm 1 – 6	Overlimit of channels
High combination alarm	OR linkage of all high alarms
Counter/integrator alarm 1 – 6	Limit infringements of counter and integrator channels (extra code required)
Counter/integrator combination alarm	OR linkage of all counter/integrator alarms (extra code required)
Combination alarm	OR linkage of all low, high and counter/integrator alarms
CF card inserted	The signal is set when a CF card is inserted in the instrument. It remains active until the card is removed.
Int. mem. alarm/CF card	The alarm is triggered when the internal storage memory available for read-out via the CF card has fallen below a certain value ¹ .
Int. mem. alarm/serial	The alarm is triggered when the internal storage memory available for read-out via the interface has fallen below a certain value ¹ .
Mem. alarm/CF card	The alarm is triggered when the storage memory available on the CF card that has been plugged in falls below a certain value ¹ , or no CF card is plugged in.
Error	Alarm when the battery is empty, or the time has to be set. Chapter 3.7 “Device info”
MODbus flag	Control flag, which can be activated through one of the interfaces.

¹ The limit for all memory alarms is the same, and is set by the parameter *Configuration* → *Device data* → *Memory alarm*.

2 Device description

Representation Representation on the screen is as follows:

Representation	
as symbol	On/off represented as switch: 
as diagram	Representation as a record over time: 

Outputs The digital signals can be used to operate three relays (extra code). The action can be configured as a break (SPST-NC) or make (SPST-NO) contact (*Configuration* → *Outputs*).

External texts External texts can be called up via four binary inputs or the logic channels. If a binary input is closed or a logic channel makes a 0-1 transition, then the preconfigured text will be entered in the event list. Either a *standard text* or one of the 18 definable texts can be used. The instrument automatically supplements the texts in order to distinguish between the appearance and disappearance of the signal. The external texts are configured on the instrument, under *Configuration* → *Control functions*.

⇒ Chapter 3.5 “Event list”

Event operation The digital signals can be used to activate event operation. In event operation, the measurements are stored with a storage cycle that is different from normal operation.

2.5 Counters / integrators / operating time counter

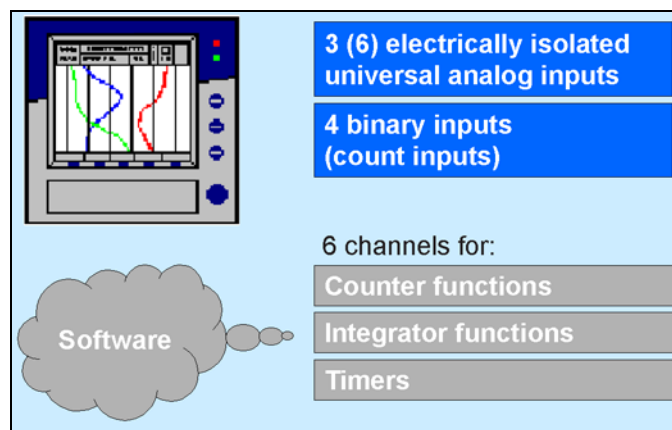

These are **not** electrical measurement inputs (hardware), but channels which are calculated by the paperless recorder (software).

Counters

- Counter inputs** Any of the digital signals can be used as input signals for the counters.
⇒ Chapter 2.4 “Digital signals (event traces)”
Example:
- binary inputs
 - logic channels
 - alarms
 - memory alarms
 - Modbus flag (signal via interface)
- Counter frequency** 30Hz max.
- Evaluation** The count pulses can be evaluated (weighted). A down counter can be implemented by entering a negative weighting (e.g. weighting factor -1).
Each count change can be documented with an entry in the event list. The new count is attached to the message.

Integrators

- Integrator inputs** Analog inputs 1 – 3 or 1 – 6 and math channels 1 – 6
- Integrator time base** sec, min, hr and day
- Evaluation** You can also enter a weighting for the integrators.
- Weighting example**
- measurement of flow volume
 - input signal of 0 – 20mA (corresponds to 0 – 500 liters/sec)
 - time base 1 sec
 - weighting 0.001
- Result: display of the integration value (volume) in m³.
- Minimum size of the input signal** Entering a threshold value (amount of the threshold value) has the effect that integration takes place only when the value has been exceeded. No integration will occur on falling below this value. The advantage of integration with a threshold value larger than 0 is that possible noise from a transducer can be suppressed in this way.



If there is an overrange or underrange on an integrator input, then integration is stopped (the latest valid value is retained), and will only continue when the input signal is correct again.

2 Device description

Operating time counter

The operating time counter will count how long a selected binary input or one of the digital signals is closed (set). The time can be displayed in sec, min, hr or days.

2.5.1 Reporting period of the counts

After an adjustable time (reporting period), the counts are stored for all counters/integrators/operating time counters. The counts for the current and the previous 7 completed reporting periods will be displayed. The following counter/integrator types are possible:

- periodic
In addition, the time period (between 1 min and 12 hrs) must be selected in the parameter *Period*.
- external
In this case, the counter/integrator is updated only when the selected control signal is active (e.g. binary input is closed). When the control signal is deactivated (e.g. binary input is opened), the counter/integrator value is saved and reset to 0.
- daily
- weekly
- monthly
- yearly
- total
- daily, from ... to
The period also has to be selected, by means of the parameters "Daily start time" and "Daily end time". The counter/integrator will then be updated from the start time only. When the end time has been reached, the counter/integrator value is saved and reset to 0.

2.5.2 Resetting the counters / integrators / operating time counters

Periodic reset There is a reporting period for each counter/integrator/operating time counter. At the end of this period, the current data (value and time) are saved and the value reset to 0. Subsequently, the next period can be recorded.

An exception is the totalizer/integrator. It is saved whenever any count/integration has been completed, but it is not reset to 0. It enables the totalizer to be evaluated in the evaluation software PCA as well.

External reset You can configure one control signal for all 6 counters/integrators together, with the result that the counters/integrators are reset to 0 **without** any **saving** of the previous values. The period for the counter/integrator summation will be restarted at this point. This means that after the test run of an installation, for instance, the recording can be freshly started; the test run values that are not required are eliminated.

⇒ see Page 69 “Generate reset”

Reset from keys Another option for resetting the counter/integrator values is provided at the parameter level. After entering the password, you can define a value for each of the 6 channels. The counter/integrator will then be set to this value. When the value is entered, after editing, a message with the new and the old count is entered in the event list.

The time period for the counter/integrator summation will not be restarted. The previous counter/integrator values will also not be saved.



If you wish to save the previous counter/integrator values, you must execute the function “Update CF incl. counters ...” in the menu for the CompactFlash card.

In this way, the recording can be freshly started for individual counters/integrators, e.g. after the test run of an installation; the test run values that are not required will be eliminated in the process.

You can select a password that is different from that for accessing the configuration. The password is set up in *Configuration* → *Device data* → *Code No. (password)* → *Reset counter / int.*

Reset from CompactFlash card menu If, in the menu *CompactFlash card*, the function *CF update incl. counters* is carried out, then the counter states will also be saved and then reset.

⇒ See “CompactFlash card” on Page 50.

2.5.3 Response to instrument reconfiguration

When the instrument is reconfigured, the current counter/integrator reporting periods remain unaffected. The counter/integrator values will not be reset to 0 and the reporting period will not be restarted.



The values can only be deliberately reset through the *Parameterization* menu.

2 Device description

2.5.4 Response at end of summer time



If a period of less than one hour has been set for counters/integrators, and the change from summer time to winter time falls precisely within this period, then the PC evaluation software (PCA3000) will forcibly set the end time to be the same as the start time. This prevents a negative period arising, and ensures that further processing is error-free.

2.6 Math/logic module

The math and logic module is available as an extra code. Like the counter/integrator/operating time counters, the math and logic module is implemented as channels that are not available as hardware but are calculated by the instrument software.

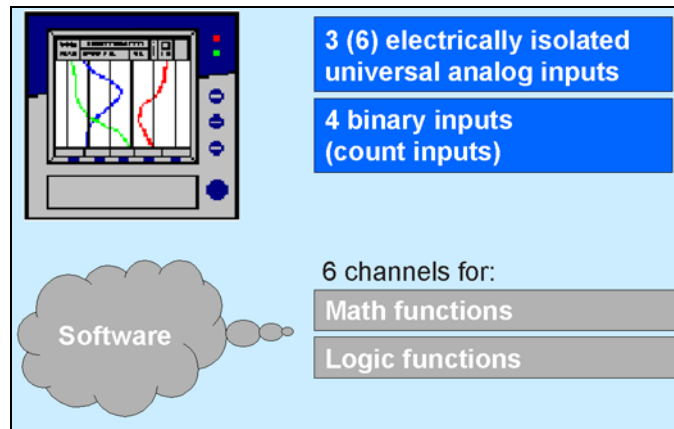

The math and logic module consists of 2 parts:

- the math module for calculating analog values and
- the logic module for calculating Boolean values (0 or 1).

Math module

With the help of the math module, measurement inputs can be used for the calculation of “virtual” math channels.

A total of 6 channels can be recorded (stored) in the instrument. In the configuration, you will find an option under *Configuration* → *Recording* → *Analog channels* → *Analog channel 1 – 6* → *Input signal* for selecting which of the analog inputs or math channels should be stored.

If more than 6 channels are to be active in the instrument (e.g. 4 analog inputs and 3 active math channels), then you can also use the visualization in the presentation mode “Large digital display (large measurements)” to see the measurements that are not stored.

⇒ Chapter 3.2.4 “Large digital display (large measurements)”

2 Device description

The following variables are used for the formulae:

- analog inputs (AE1 — AE6)
- math channels (MAT1 — MAT6)
- counter/integrator channels (ZI1 — ZI6)
- binary inputs (BE1 — BE4)
- alarms
- errors
- Modbus flag (signal via interface)
- instrument-specific data (only after consultation with the manufacturer)

If counter/integrator values are used for calculation, then please note that their accuracy is reduced, since, in this case, two different data formats have to be used for calculation. The counters/integrators are calculated in the double-float format, whereas the math module employs a single-float format that follows the IEEE 754 standard. Nevertheless, it is possible to include these values in the math module.

The following fixed functions are available:

- difference
- ratio
- relative humidity (psychrometric measurement)
- moving average

For the moving average, the reference channel has to be entered (in most cases, the analog input number) and the time period (in minutes) for calculating the moving average.

The following operators and functions are available for the formulae: +, -, *, /, (,), SQRT(), MIN(), MAX(), SIN(), COS(), TAN(), **, EXP(), ABS(), INT(), FRC(), LOG(), LN().

On going above or falling below the scalable values, the math channel is treated as for “out-of-range”.

The formulae are entered in the PC, in the setup program. The mathematical formulae cannot be edited by using the keys on the instrument.



For further information, refer to
Chapter 5.9 “Math/logic”

2 Device description

Logic module

You also have up to 6 channels available as logic channels.

As is the case with all the other digital signals, the calculated digital (Boolean) values can be used for different functions:

- recording in the event traces,
- as a control signal for display switch-off,
- clock time synchronization,
- operating time counter,
- externally controlled counters / integrators
- counter/integr. reset
- event operation and key inhibit,
- for output to a relay and
- as count input for a counter.

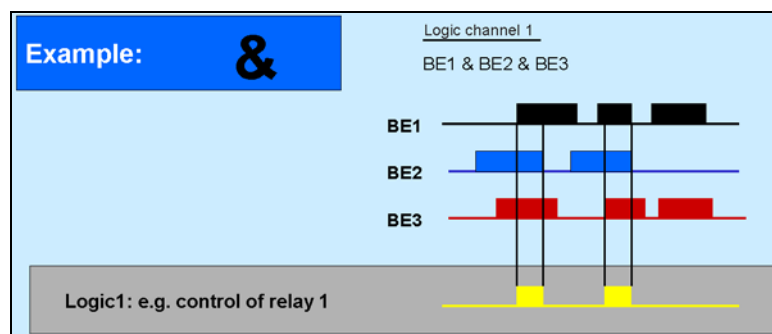

The following variables are used for the formulae:

- binary inputs
- logic channels
- alarms
- errors
- Modbus flag (signal via interface)
- TRUE
- FALSE
- device-specific data (only after consultation with the manufacturer)

These functions can be used for the formulae:

- ! (NOT)
- & (AND)
- | (OR)
- ^ (XOR)
- / (rising edge)
- \ (falling edge)
- ((open bracket)
-) (close bracket)



For further information, refer to Chapter 5.9 “Math/logic”

2.7 Operating modes

3 operating modes The instrument has 3 operating modes:

- normal operation
- timed operation
- event operation

The following settings can, among others, be made for each of the three operating modes:

- stored value
- storage cycle

Stored value The stored value setting determines what is stored: average, minimum, maximum or momentary value between two storage cycles, or the peak value (envelope). The setting “peak value” means that the maximum and minimum values from the last storage cycle are saved.

Storage cycle The storage cycle determines the interval between two stored values. The diagram speed corresponds to the storage cycle, which means that with a storage cycle of 5sec, for example, the stored value is entered in the diagram every 5sec.

Normal operation Normal operation is active whenever event or timed operation is not active.

Timed operation For timed operation, a period of time can be defined (up to 24 hrs) within which a specific stored value and a specific storage cycle are active.

Event operation Event operation is active as long as its control signal (⇒ Chapter 4.2.6 “Configuration - Recording”) is active. Event operation can be used, for example, to shorten the storage cycle when an alarm is present.

Priority The respective priorities of the operating modes are allocated as follows:

Operating mode	Priority
Normal operation	low
Timed operation	average
Event operation	high

Active operating mode The active operating mode is shown in the diagram by the background color for the diagram speed:

Operating mode	Color
Normal operation	gray
Timed operation	turquoise
Event operation	orange

⇒ Chapter 2.2 “Operating principle and graphic elements”

2 Device description

2.8 Storing data

Life-cycle data management

The integrated life-cycle data management puts users in the position of being able to save all the process data from the system that is being monitored in an archive file on their PCs or a server system.

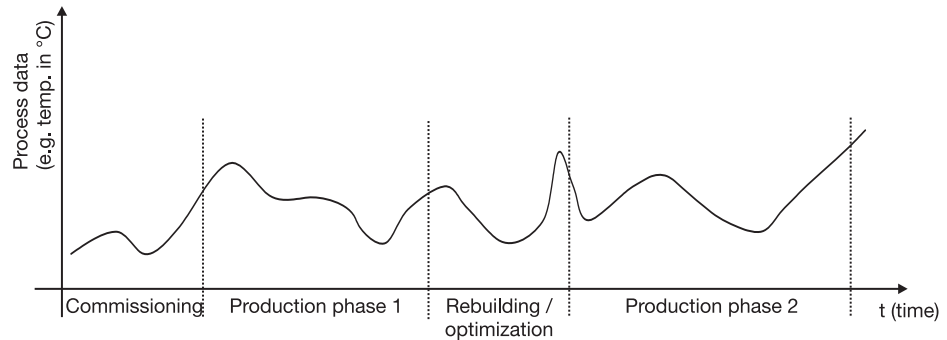

The recovery of configuration-dependent system data, which may be required for commissioning, maintenance or optimization during the life-cycle of a system, is now enabled by the associated PC evaluation software (PCA3000) in a dialog window.

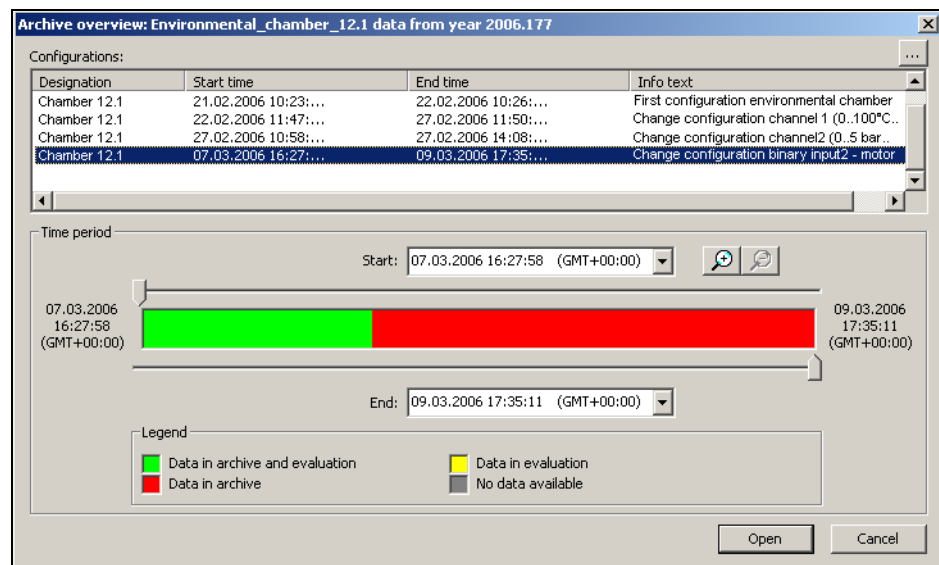

2 Device description

Operating principle

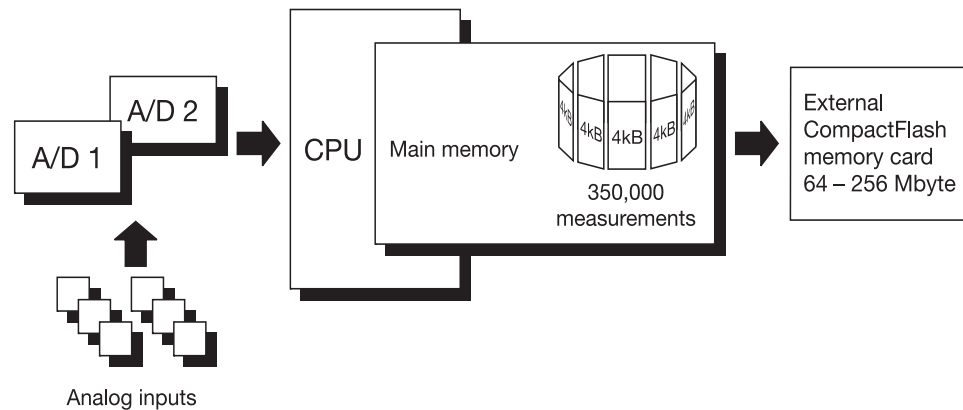

The measurements from the analog inputs are acquired continuously in a 250msec sampling cycle, and then stored in the main memory. These measurements also serve as the basis for limit monitoring.

Main memory (FLASH memory)

The data stored in the main memory are regularly copied to the CompactFlash card in 4 kbyte blocks. The main memory is written to as a ring memory, i.e. when it is full, the oldest data will automatically be overwritten by new data. The capacity of the main memory is sufficient for approximately 350,000 measurements. The instrument monitors the capacity of the main memory and activates the “Memory alarm (internal)” signal if the level falls below a configurable residual capacity.

CompactFlash card

For saving the data, CompactFlash cards (industrial grade) can be used with the following storage capacities: 64/128/256MB.

The instrument monitors the capacity of the CompactFlash card, and activates the “Memory alarm (CF card)” signal if the level falls below a configurable residual capacity. This signal can be used, for instance, to operate a relay (warning signal “Swap CF card”).

Data security

The data are stored in coded form in a proprietary format. If the CompactFlash card is removed from the instrument, no data will be lost immediately, as these data are still stored in the FLASH memory. A loss of data will only occur if, after the CompactFlash card has been removed, the FLASH memory is completely rewritten as well, and no data have been read out through the interface.

Storage cycle

Different storage cycles, ranging from 1sec to 32,767sec can be configured for normal, event and timed operation under “configuration”.

The storage cycle determines the time intervals at which the measurements are stored.

Stored value

Under this parameter, separate configurations are made for normal, event and timed operation, to decide which value is stored (average, momentary, minimum, maximum, peak values).

2 Device description

Recording duration

The recording duration depends on various factors:

- number of analog channels and event traces being recorded
- storage cycle
- number of events in the event list.

Internal recording duration (without external CF card)

Number of channels	Memory size	Storage cycle 1 min	Storage cycle 30 sec	Storage cycle 10 sec	Storage cycle 1 sec
3	approx. 1 MB	42.2 days	21.1 days	7 days	17 hours
6	approx. 1 MB	29.5 days	14.8 days	4.9 days	12 hours

Recording duration with CF card

Number of channels	Memory size	Storage cycle 1 min	Storage cycle 30 sec	Storage cycle 10 sec	Storage cycle 1 sec
3	64 MB	8.8 years	4.4 years	1.5 years	1.8 months
3	128 MB	17.6 years	8.8 years	2.9 years	3.5 months
3	256 MB	35.3 years	17.6 years	5.9 years	7.1 months
6	64 MB	6.2 years	3.1 years	1.0 years	1.2 months
6	128 MB	12.3 years	6.2 years	2.1 years	2.5 months
6	256 MB	24.7 years	12.3 years	4.1 years	4.9 months

The calculation of the recording duration is made for the storage of momentary, minimum, maximum or average values. If peak values are recorded, then the times are shorter, since a maximum and minimum value is recorded each time.

The recording capacity will be further reduced if a large number of event messages are also stored.

Optimization of recording duration

The recording duration can be optimized by process-oriented selection of the storage cycle.

In normal operation (no error, no alarm, ...) a storage cycle that is as long as possible (e.g. 60sec, 180sec, ...) should be selected, depending on the particular application.

In the event of an alarm or error, the storage cycle can be shortened via event operation, with the effect that the measurement data are recorded with a high time resolution.

2.9 Read-out of data

In addition to automatic read-out via the external CompactFlash memory card, measurement data can also be read out through one of the interfaces (RS232, RS485, setup, Ethernet).

Both read-out options (card/interface) work in parallel. For this reason, there are also two “digital signals”, which indicate when the available storage space has fallen below a certain configurable value.

Memory alarm The limit for alarms can be set by the parameter *Configuration* → *Device data* → *Memory alarm* in the configuration level.

The parameter *Configuration* → *Memory upload* can be used to determine which storage space indication should be shown in the status line. The “digital signals” for storage space detection function independently of the indication in the status line.

Digital signals **IntMemAlm/CF**

If this signal is set, it means that no data have been fetched by the CF card for a long time, and the available capacity of the internal memory has fallen below the configured level.

IntMemAlm/ser

If this signal is set, it means that no data have been fetched by the interface for a long time, and the available capacity of the internal memory has fallen below the configured level.

MemAlmCFcard

If this signal is set, it means that not enough space is available on the CF card. The program PCA3000 can help here. Use PCA3000 to read in the data, save them to the hard disk on a network, and free up the space on the CF card. Alternatively, you can use a new CF card.

Data lost A loss of data is only imminent if all three of the above signals are set.

Read-out via interface Use the PCA Communications Server software (PCC) to read out measurement data via the serial, setup or Ethernet interface. The software has been developed especially for the paperless recorder.

⇒ Please refer to the Operating Manual 59500 for further information.



Use the same archive (in the PC) for reading out via the interface as for reading out with the CF card. This saves having to put together data from different files at a later date.

2.10 Evaluating data

Please use the PC Evaluation Software (PCA3000) for evaluating the data on the PC. The software has been developed especially for the paperless recorder.

⇒ Please refer to the Operating Manual 59498 for further information.

2 Device description

2.11 Webserver

If the paperless recorder is equipped with the extra code “Ethernet interface”, and the device-internal Ethernet software (“Ethernet version”) has the number 183.02.03 or higher, then the paperless recorder has an inbuilt webserver. The webserver can be started by entering the IP address in an Internet browser on the PC (e.g. <http://10.10.90.45>).

Device name	Recorder 1		
Analog channels	Analog input 1	25.1	%
	Analog input 2	45.8	%
	Analog input 3	61.2	%
	Analog input 4	20.1	%
	Analog input 5	50.0	%
	Analog input 6	80.5	%
Counters / integrators	per. Counter AI1(10min)	3	
	Day. Counter Alarm Input1	45	
	Total Count. Alarm Input1	2960	
	Integrator AI1 (day.)	8194737.4781	
	Total time Alarm Input1	8162	min
Event traces	C.alarm	0	
	CF ins.	0	
	I.mem.1	0	
	I.mem.2	0	
	I.mem.3	1	

The variables that are shown are acquired and displayed automatically by the webserver. The latest data are read out of the instrument every 5 seconds. Any limit infringements show a red background. A maximum of 6 channels (analog or math channels), up to 6 counters or integrators, and a maximum of 6 event traces.

2 Device description

Display of ...	Activated through menu ...
Device name	Configuration - Instrument data - Device name
Analog or math channels	Configuration - Recording - Analog channels
Counters or integrators	Configuration - Counter/integrator
Event traces	Configuration - Recording - Event traces

Only the activated signals will be displayed.

The information about the “Ethernet version” can be found in the “Device info” menu.

⇒ Chapter 3.7 “Device info”



Only 1 PC (client) at a time can access the device (server) via the Ethernet interface.

Since the paperless recorder is only polled by the Internet browser every 5 seconds, it is possible that, for instance, the PCC data transfer software takes over control of the paperless recorder during this interval. After securing the data, PCC will end access to the recorder, so that the Internet browser can read out data again.

2 Device description

3 Operation and visualization

After starting up the paperless recorder by switching on the supply (power ON), you will see the start logo.



During screen build-up, the recorder is initialized with the data of the last configuration.



After the initialization phase, the measurement diagram (visualization level) is displayed.



By using the setup program, an individual start logo (bitmap with a maximum of 16 colors) can be loaded into the instrument, through the function *Extras* → *Start screen*.

3 Operation and visualization

3.1 Basic menu

The basic menu is the central point from which the various instrument levels branch out.

The following levels are available:

- ⇒ Chapter 3.2 “Visualization”
- ⇒ Chapter 3.3 “Parameterization”
- ⇒ Chapter 3.4 “Configuration”
- ⇒ Chapter 3.5 “Event list”
- ⇒ Chapter 3.6 “CompactFlash card”
- ⇒ Chapter 3.7 “Device info”

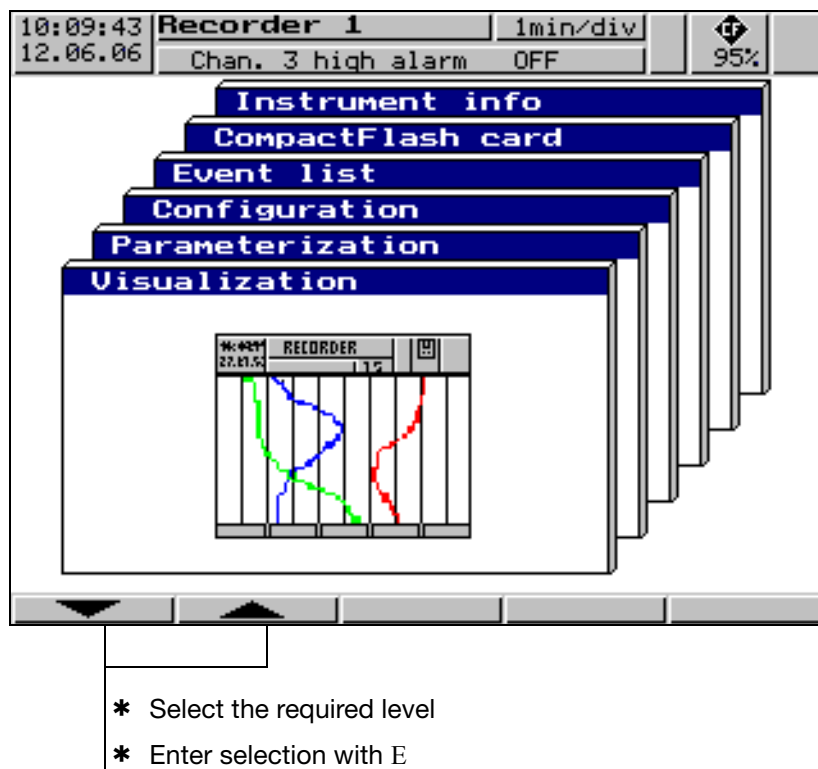

The basic menu is displayed after pressing the Mkey¹.

¹ Not from the configuration level, if a parameter has already been modified there.

3 Operation and visualization

3.2 Visualization

As already mentioned in Chapter 2.2 “Operating principle and graphic elements”, the softkeys are arranged at the bottom of the screen. They change their function according to the menu and are shown as symbols or plain text.

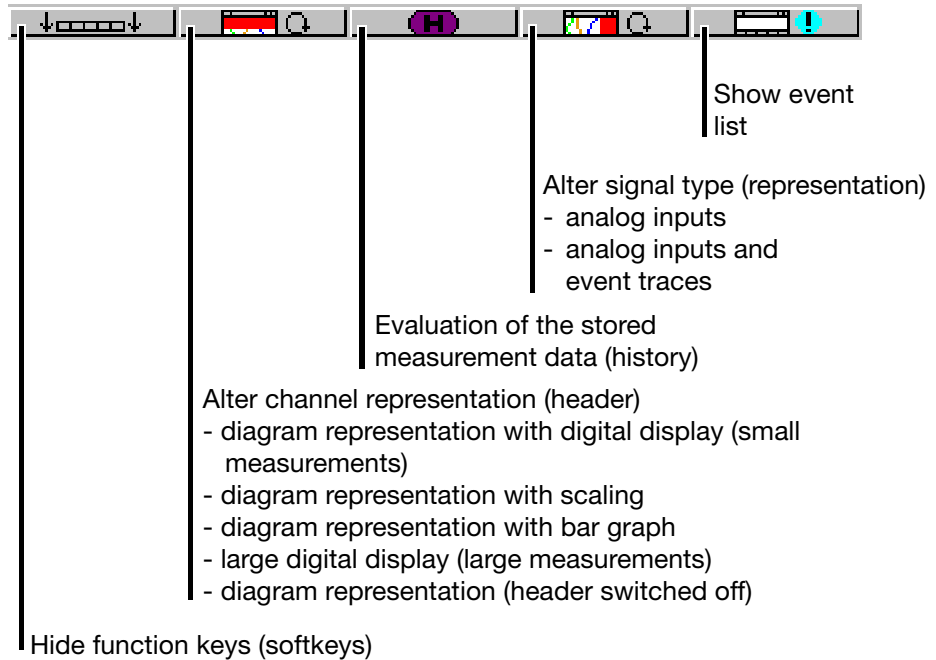

If the paperless recorder is equipped with “Counters/Integrators” (extra code), the symbol for indicating the counts will now appear below the softkey on the right, the symbol for showing the event list is shifted to the counter display.

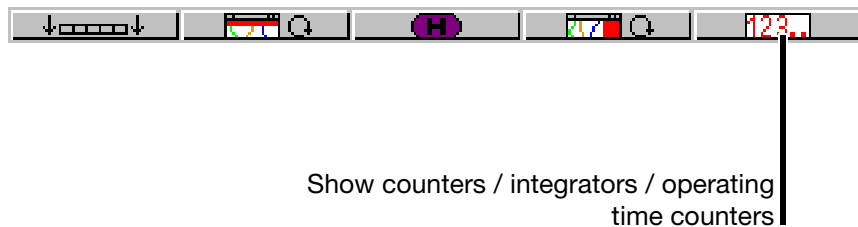



3 Operation and visualization

3.2.1 Diagram representation with digital display (small measurements)

Diagram representation can be reached from the basic menu, by calling up the "Visualization" menu or by pressing the D key.

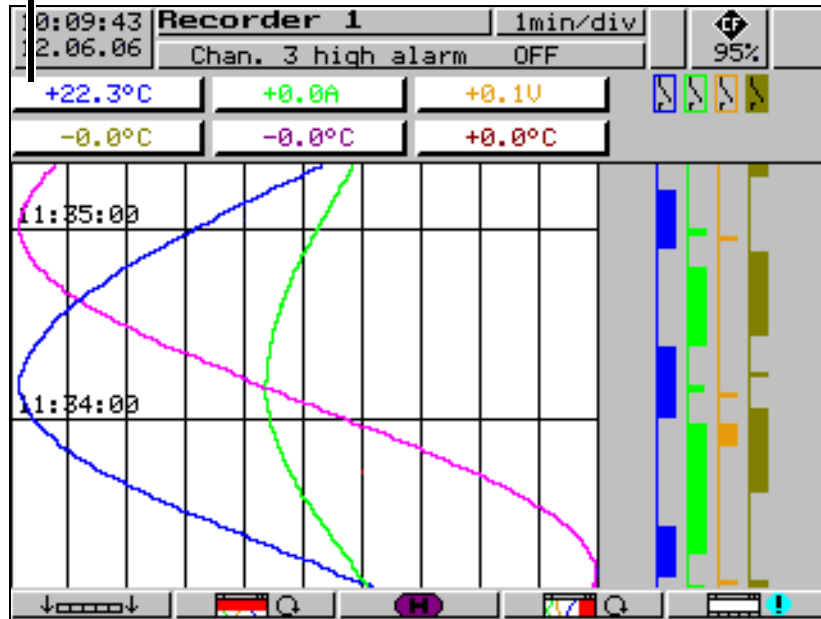
- current measurements of the analog inputs, including dimensional unit
- measurement on a red background ⇒ out of limit



By using the parameter *Parameterization* → *Diagram view* → *Signal type* (or the  button), it is possible to select whether, in addition to the analog channels, the event traces are to be displayed as well. The contents of the header are determined by means of the parameter *Parameterization* → *Diagram view* → *Channel representation* (or the  button).

3 Operation and visualization

3.2.2 Diagram representation with scaling

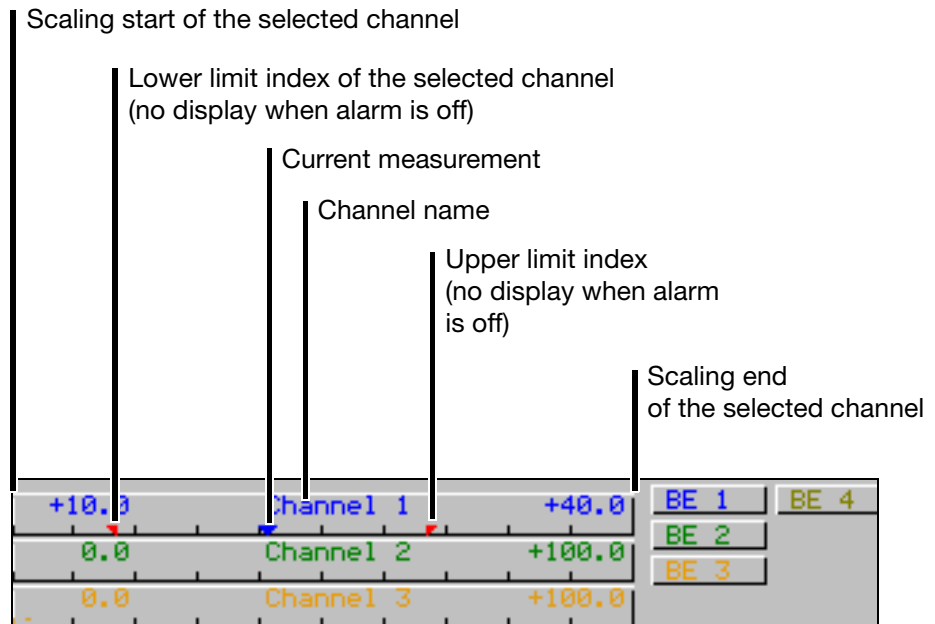

Which scaling (on which channel) is to be displayed can be selected through the parameter *Parameterization* → *Diagram view* → *Channel indication*.

3.2.3 Diagram representation with bar graph

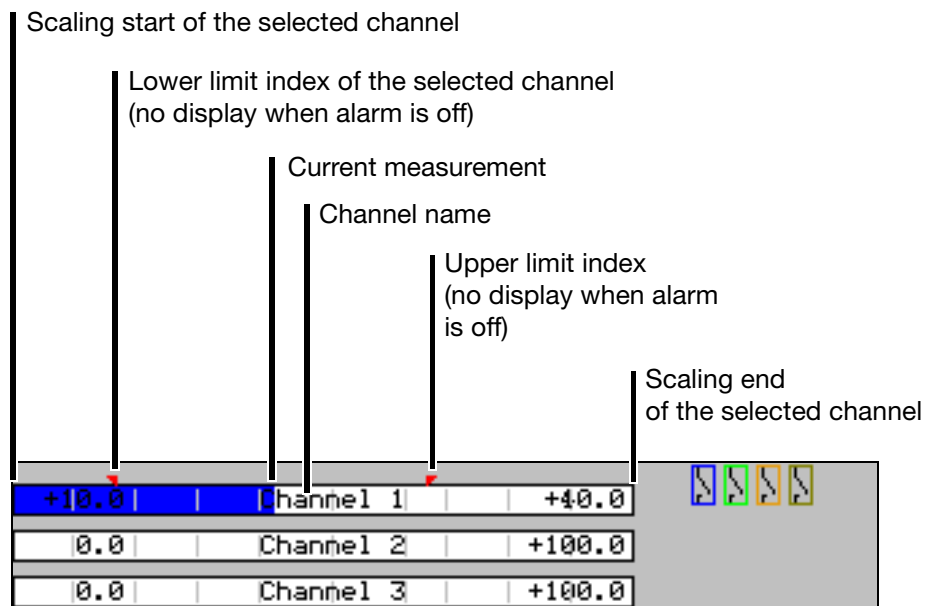

Use the parameter *Parameterization* → *Diagram view* → *Channel indication* to select which bar graph (from which channel) is to be displayed.

3 Operation and visualization

3.2.4 Large digital display (large measurements)

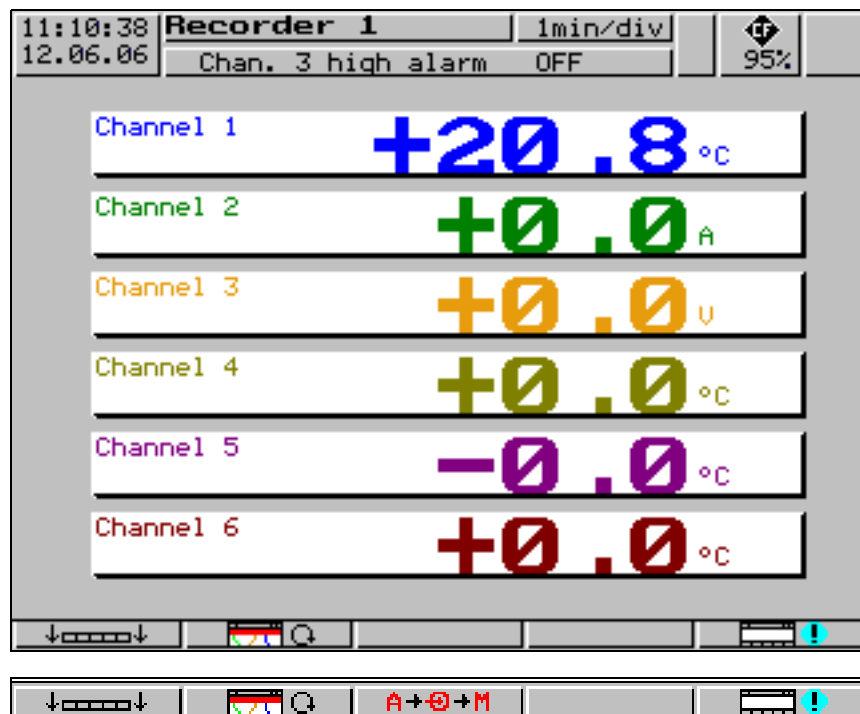

This display type is limited to the digital display.

If more than 6 signals are active (for instance, 6 analog inputs and 3 math channels), the **A+⊕+M** button is switched into the display. It can be used to switch between the individual signals.

- A** - recorded analog channels (channels selected through the parameter *Configuration* → *Recording* → *Analog channels*)
- ⊕** - all analog inputs
- M** - all math channels

3 Operation and visualization

3.2.5 Curve representation (header switched off)

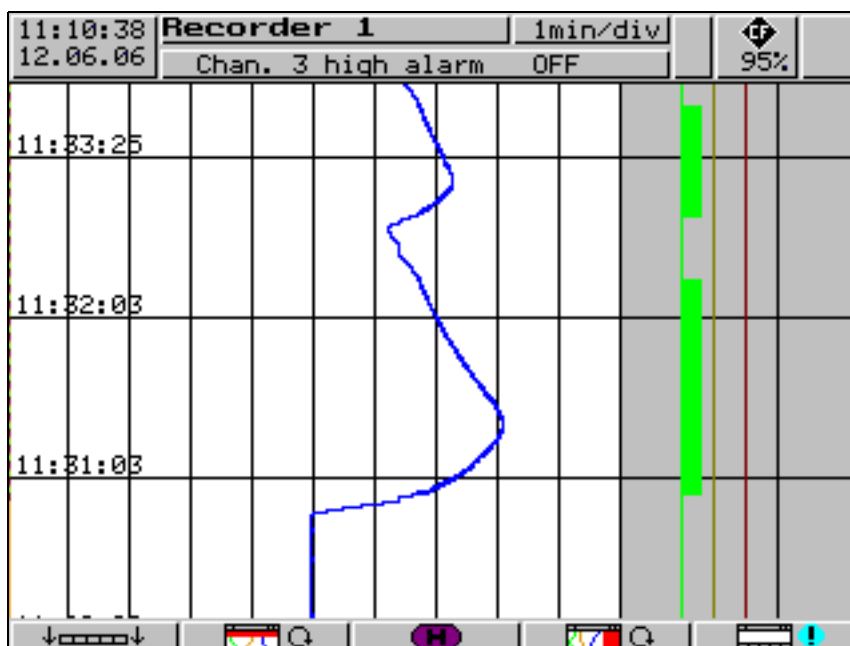

This display type is limited to the curve display.

3 Operation and visualization

3.2.6 Evaluation of the stored measurement data

History



The softkey function changes during evaluation. In addition, the current zoom factor and cursor position (date and time) will be shown.

Scroll operation

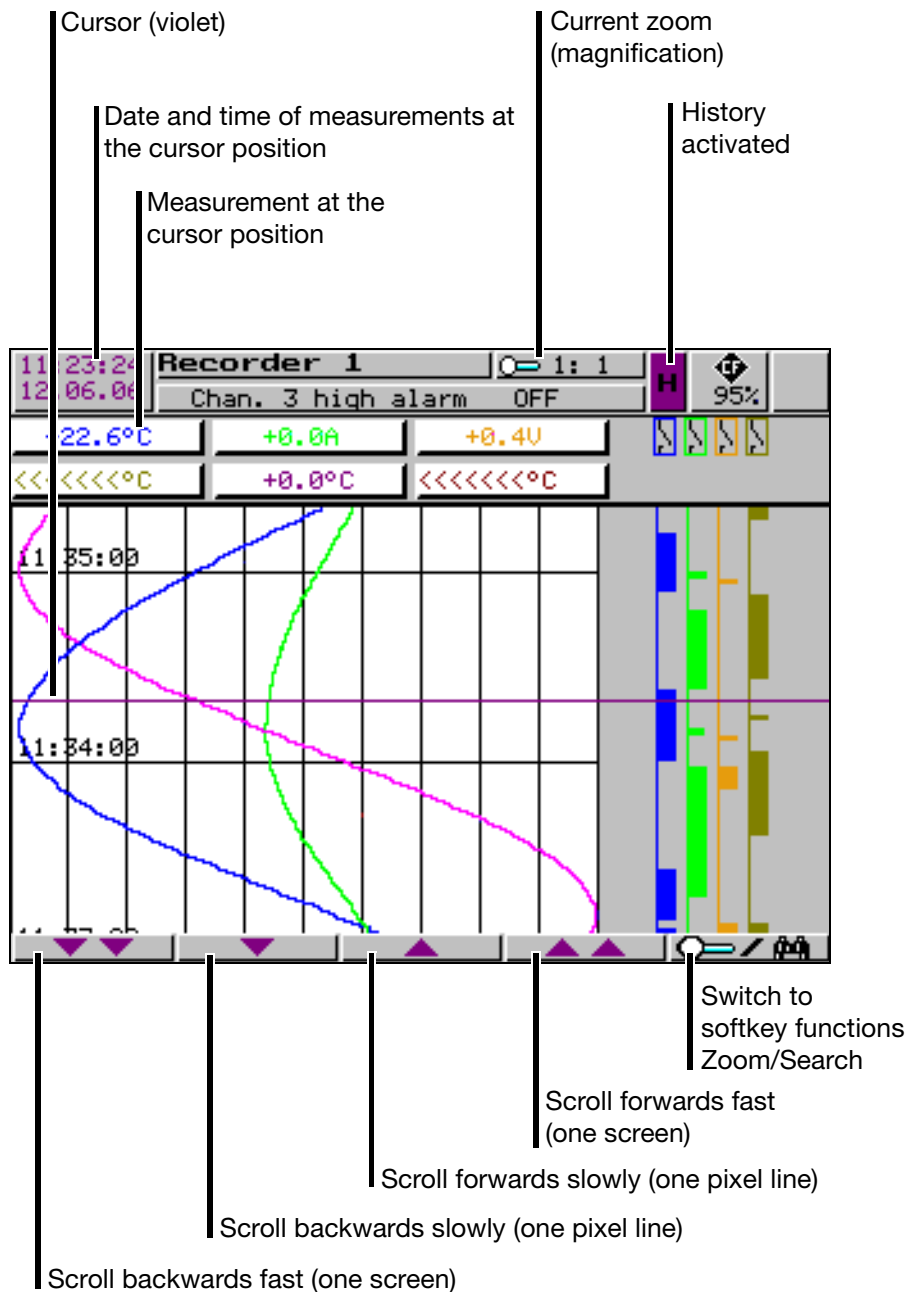

Using these softkeys, the measurement data display can be scrolled (shifted) on the screen within the measurement data stored in the internal memory.



Measurement acquisition remains active during history representation.

3 Operation and visualization



Scrolling backwards within the internally stored measurement data is possible up to the last changeover from summer time to normal time.

Zoom

If the zoom factor has to be adjusted, or specific times have to be searched, then it is necessary to switch the softkey functions.

* Press  softkey

The degree of compression of the measurement data on the screen is given as a ratio in steps (1:1, 1:2, 1:5, 1:10, 1:20, 1:50 and 1:100).

For instance, a ratio of 1:100 means that 1 screen pixel corresponds to 100 measurements, i.e. only every hundredth stored measurement is displayed.

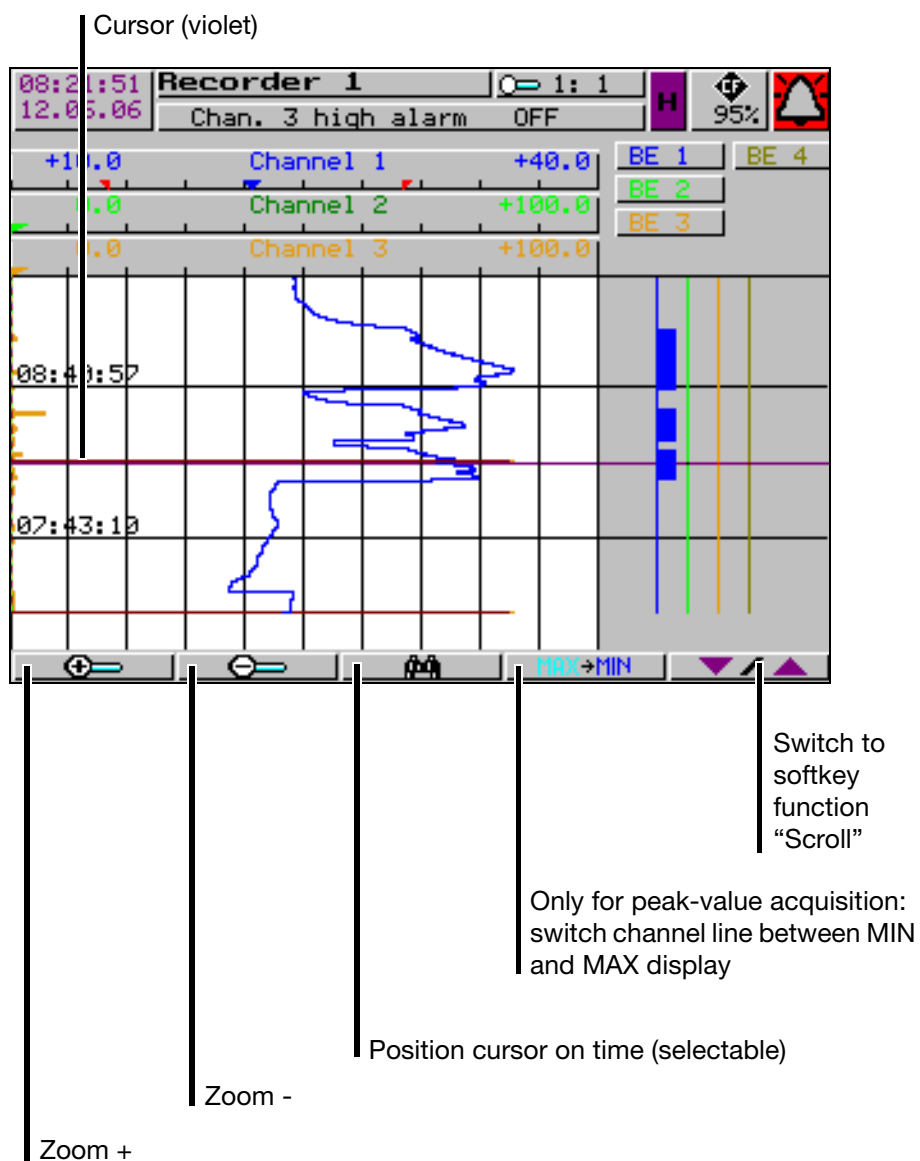

3 Operation and visualization

Cursor positioning



After activating the button, the following dialog appears for positioning the cursor on a specific time:





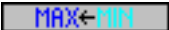

After entering the date and time and activating , the cursor is positioned on the selected time.

If no measurement data have been stored for the selected time, then the cursor is positioned on the next possible time.

Peak-value acquisition

If the data have been recorded in the “peak value” mode, then two different measurements (one minimum and one maximum value) may be displayed graphically for one instant of time (storage cycle). Using the  key, it is possible to switch between minimum and maximum value display within the “measurement” display mode.

	Function key	Channel line
Minimum		
Maximum		

Peak value acquisition is programmed (activated) through the parameters:

- Configuration → Measurement storage → Normal display → Stored value
- Configuration → Measurement storage → Event operation → Stored value
- Configuration → Measurement storage → Timed operation → Stored value

For further information about the “measurement” display mode, see Chapter 3.2.1 “Diagram representation with digital display (small measurements)” and Chapter 3.2.4 “Large digital display (large measurements)”.

3 Operation and visualization

3.2.7 Counters / integrators / operating time



Count display is optionally available (extra code). If it is available, a screen such as the following will appear after the softkey has been pressed, in which the current counts are shown in a numerical form.

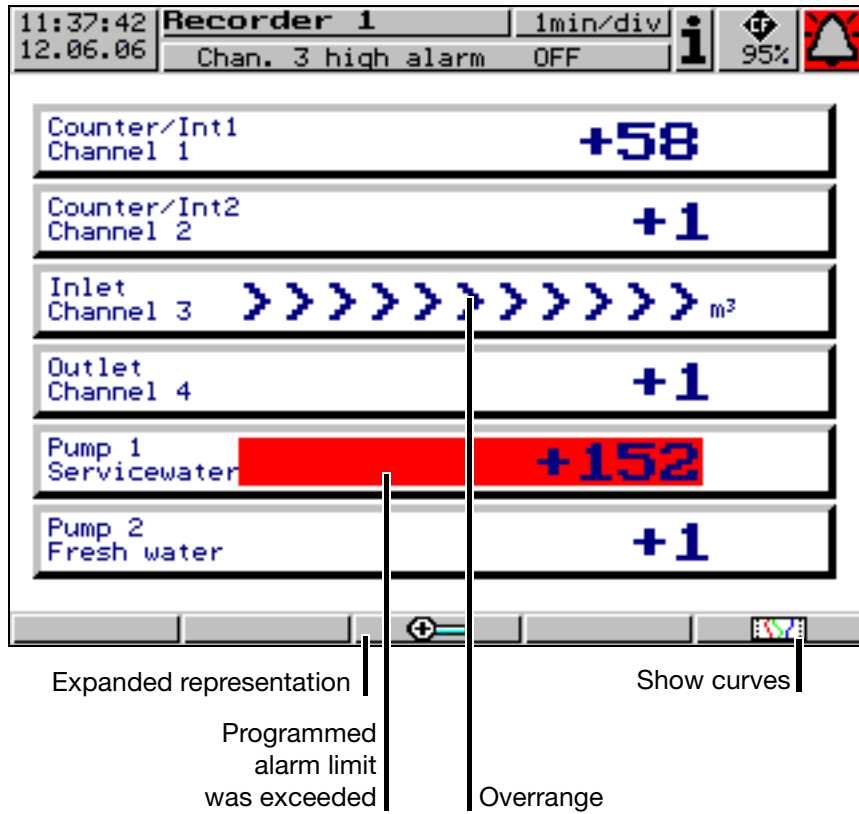

Press the softkey to activate the expanded representation.

3 Operation and visualization

Expanded representation

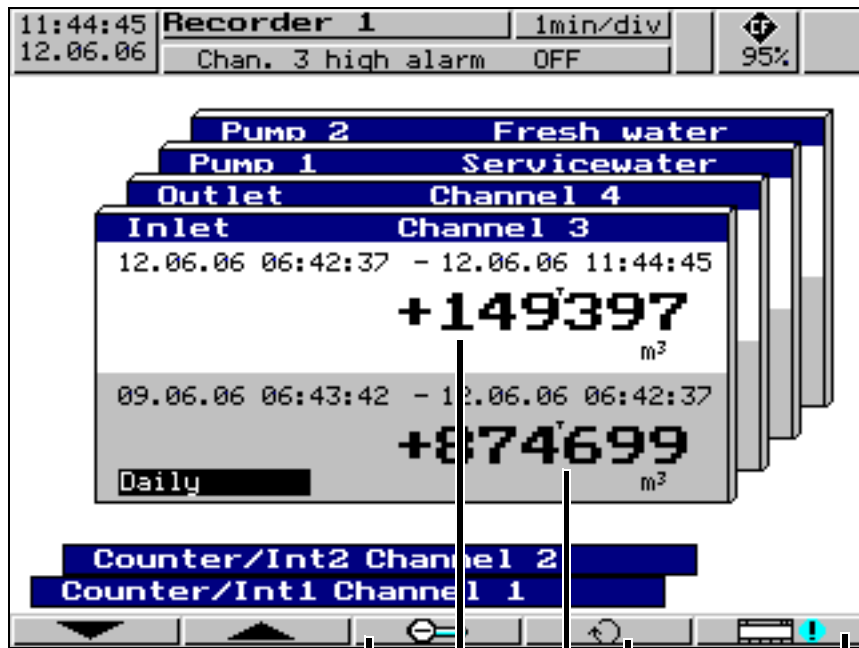

Normal representation

Current count
Concluded reporting period

Show next concluded reporting period

The last 7 concluded reporting periods can be shown, one after another, by pressing the key.

Event list
see
Chapter 3.5
"Event list"

3 Operation and visualization



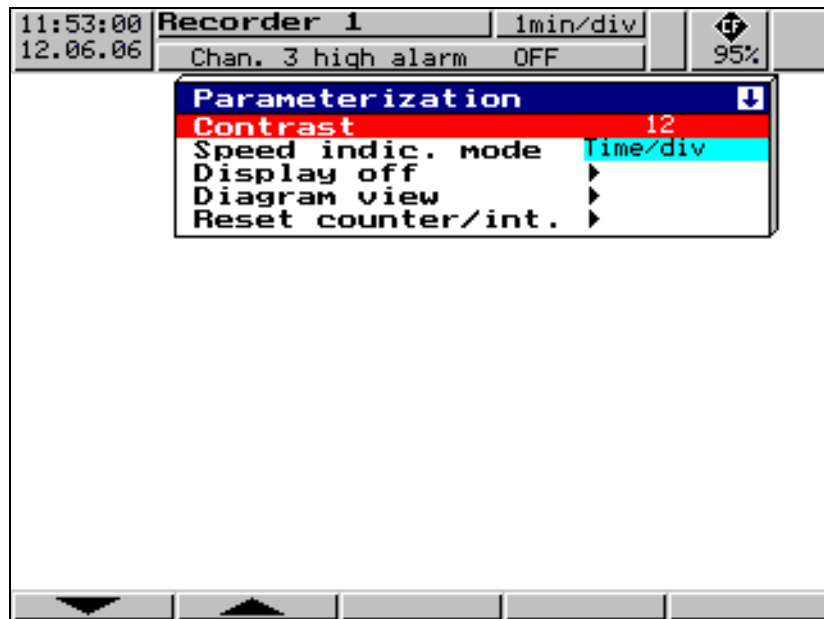

3.3 Parameterization



The Parameter level is available to set

- contrast,
- speed indication
- display off
- diagram view and
- counter/integrator reset.



All parameters are selected using the  and  or  and  keys.

Contrast

The contrast of the screen can be set here. This ensures that the screen is always highly legible, even under difficult light conditions.

Speed indication

“mm/h”, “time/div” or “storage cycle” is selected here for the speed display in the diagram.

Example: a diagram speed of 1 hr/div correspond to approx. 22mm/hr.

3 Operation and visualization

Display off (screen saving)

Switch-off event = waiting time

For screen saving, a time between 0 and 32,767min can be set under the parameter "Waiting time". If no key on the recorder is operated during this time, then the screen goes dark. The power LED blinks during screen saving. Screen saving can be canceled by pressing any key on the recorder.

If 0min is set, then screen saving is deactivated.

Switch-off event = control signal

In this case, screen saving is performed through one binary input (extra code) or a different control signal. The binary input is selected via the parameter "Control signal".

As long as the signal is present, the screen remains switched off. A waiting time is not allowed for.

Screen saving is deactivated when "Off" is selected.



Only one type of screen saving can be active at any time.

Diagram view

Diagram view → Signal type

The representation mode of the measurements and event traces are determined here:

- analog inputs
- analog inputs and event traces.

Diagram view → Channel representation

The contents of the channel bar is selected here:

- small measurement
- scaling
- bar graph
- large measurements
- switched off.

Diagram view → Channel indication

The channels which are displayed in the channel line, in the representation mode "Small measurement" "Scaling" and "Bar graph" are selected here.

Diagram view → Paper perforations

This can only be selected if only the analog channels and **no** event traces are displayed. When Yes is set, paper perforations appear in the diagram, thus giving the picture the appearance of a conventional chart recorder.

3 Operation and visualization

Counter/ integrator reset

After the password has been successfully entered, the counts for each of the 6 channels can be set to 0 or a defined value in this menu.

When a value has been entered (confirm with the E key), a message with the new and old count is entered in the event list. The time period for the counter/integrator summation will not be restarted. The previous counter/integrator values will also not be saved. If you wish to do so, you have to carry out *Update CF card incl. counters* in the *CompactFlash card* menu before resetting.

In this way, the recording can be freshly started for counters/integrators, e.g. after the test run of an installation. The test run values that are not required will be eliminated in the process.

You can select a password that is different from that for accessing the configuration. The default value is also 09200.

The password can be set in the menu *Configuration* → *Device data* → *Code No. (password)* → *Reset counter/int.*

3 Operation and visualization

3.4 Configuration

When you call up the configuration level, you will be asked to enter the password (factory setting: 09200). This also serves to prevent unauthorized alteration of the configuration.

After entering the password, a warning appears, which must be acknowledged with the E key.

⇒ Chapter 3.10 “Code number (password query)”

Window technology

As for the other levels, the configuration principle is also based on menu-led window technology. Individual menu items can be selected in the windows. The window title describes the contents of the window.

If a menu item is selected, a further window is opened with new menu items, until the required parameter is finally reached. If several windows are open, the window title assists in orientation.

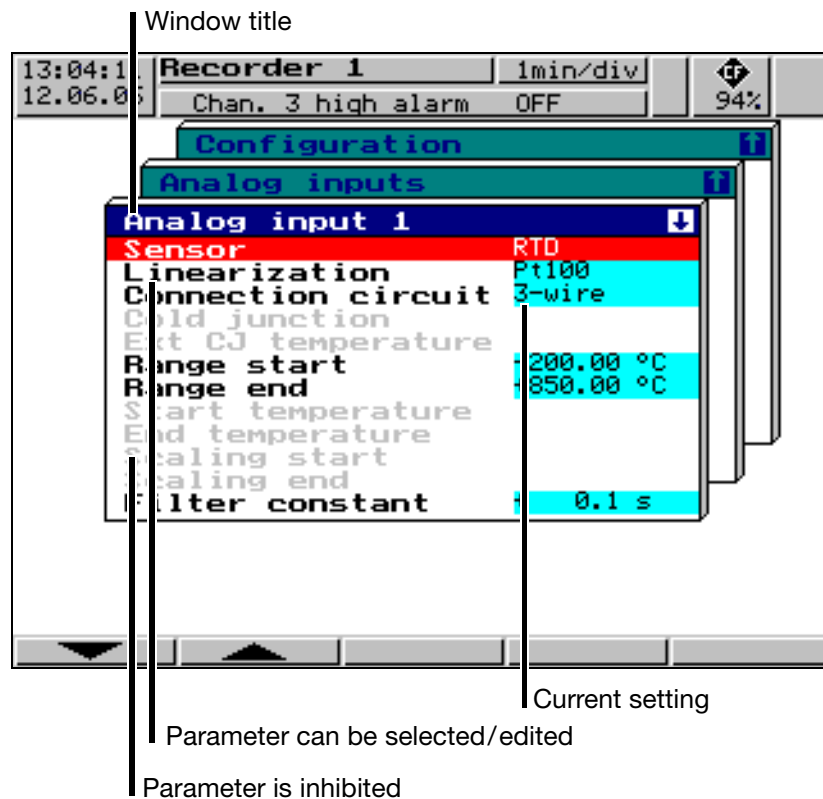

3 Operation and visualization

The configuration of the recorder is sub-divided into the following levels:

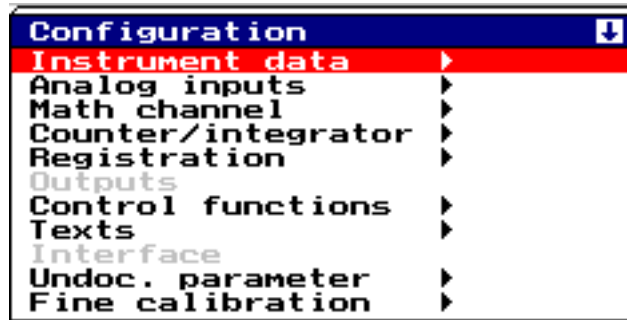

⇒ Chapter 4 “Configuration parameters”

3.5 Event list

Events

Various events can initiate texts which are incorporated in the event list and saved to the internal memory or CF card. Events may include:

- alarms triggered by out-of-limit conditions on individual channels,
- external texts triggered through binary inputs or logic channels,
- system messages (e.g. power ON/OFF, summer/winter time changeover),
- count-up of a counter,
- any message text of up to 20 characters that was transmitted to the device via one of the interfaces.

Event definition

For all events, except for system messages, it is possible to configure whether:

- the message text is to be included in the event list,
- the device-internal standard text
- or one of the texts (see below) is used.

Text assignment

The texts (standard texts or 18 freely definable texts) are assigned to events at the operating level “Configuration” (⇒ Chapter 4 “Configuration parameters”).

Freely definable texts

18 texts can be freely defined, up to a length of 20 characters.

3 Operation and visualization

Standard texts The recorder offers standard texts as listed in the following table:

Standard text	Comment
Channel _x low alarm ON Channel _x low alarm OFF Channel _x high alarm ON Channel _x high alarm OFF Counter/int. alarm x ON Counter/int. alarm x OFF Binary input y ON Binary input y OFF Logic channel y ON Logic channel y OFF	x = channel number y = input number
Counter x: y	x = counter channel number y = counter value (9 digits)
Power ON Power OFF Data lost Summer time start Summer time end New configuration Counter/int. x reset from y to z	x = counter/int. channel number y = old counter/int. value (9 digits) z = new counter/int. value (9 digits)
"Text 1 – 18"	18 freely definable texts with 20 characters each

Supplementary text The recorder automatically supplements the texts by "ON" or "OFF" in order to distinguish between the appearance and disappearance of the signal.

Example:

Standard text	Supplementary text	Entry in event list
Binary input 2	ON	Binary input 2 ON
Binary input 2	OFF	Binary input 2 OFF

3 Operation and visualization

Basic menu →
Event list

The event list is called up via the basic menu:

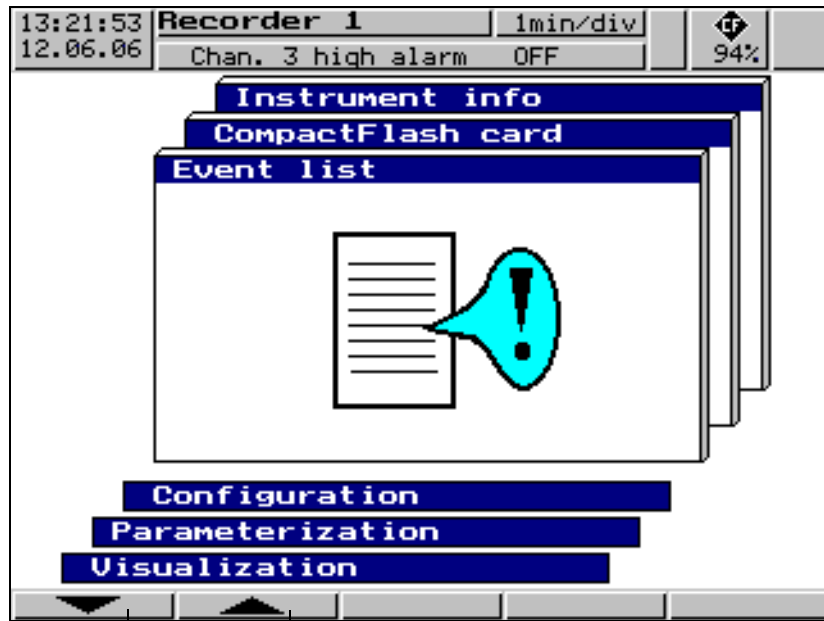

- * Select operating level *Event list*
- * Enter selection with E

Event list



jump back directly into diagram presentation

3 Operation and visualization

3.6 CompactFlash card

Automatic storage of measurement data

The data stored in the measurement data memory (FLASH) of the paperless recorder are saved at regular intervals to the CompactFlash card¹ in the instrument. The PC evaluation program (⇒ Chapter 7 “PC programs”) reads the data from the CF card and provides user-friendly functions for evaluation.

Loading and saving the configuration data

The configuration data can be downloaded from the CF card and saved to the CF card. A configuration can thus be copied from one instrument to another, or it can be transferred from and to the PC setup program.



Only one configuration file can be saved to the CF card at any time. If there is a configuration on a CF card, this will be overwritten without any further query through the function *CompactFlash card* → *Config. data* → *CF card*.

Basic menu → CompactFlash card

The CompactFlash menu is called up via the basic menu:

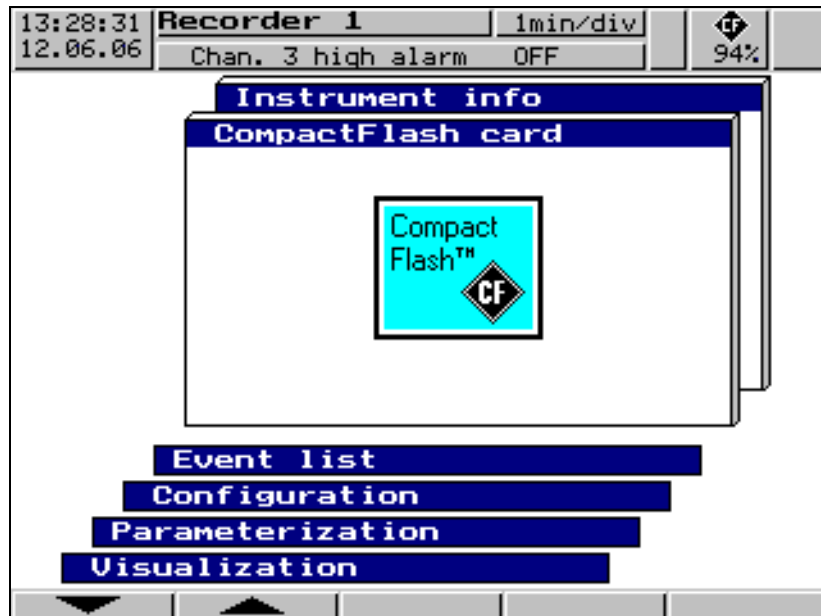

- * Select operating level *CompactFlash card*
- * Enter selection with E

The functions

- *Update CF incl. counters ...*,
- *Compl. meas. data* → *CF*,
- *Config. data* → *CF card* and
- *CF card* → *Config. data*

are protected against unauthorized access by a password query (factory setting: 09200).

¹ PC Card access made available by CSM FAT File System
Copyright © 1997-2002 CSM GmbH Filderstadt, Germany

3 Operation and visualization

CompactFlash card

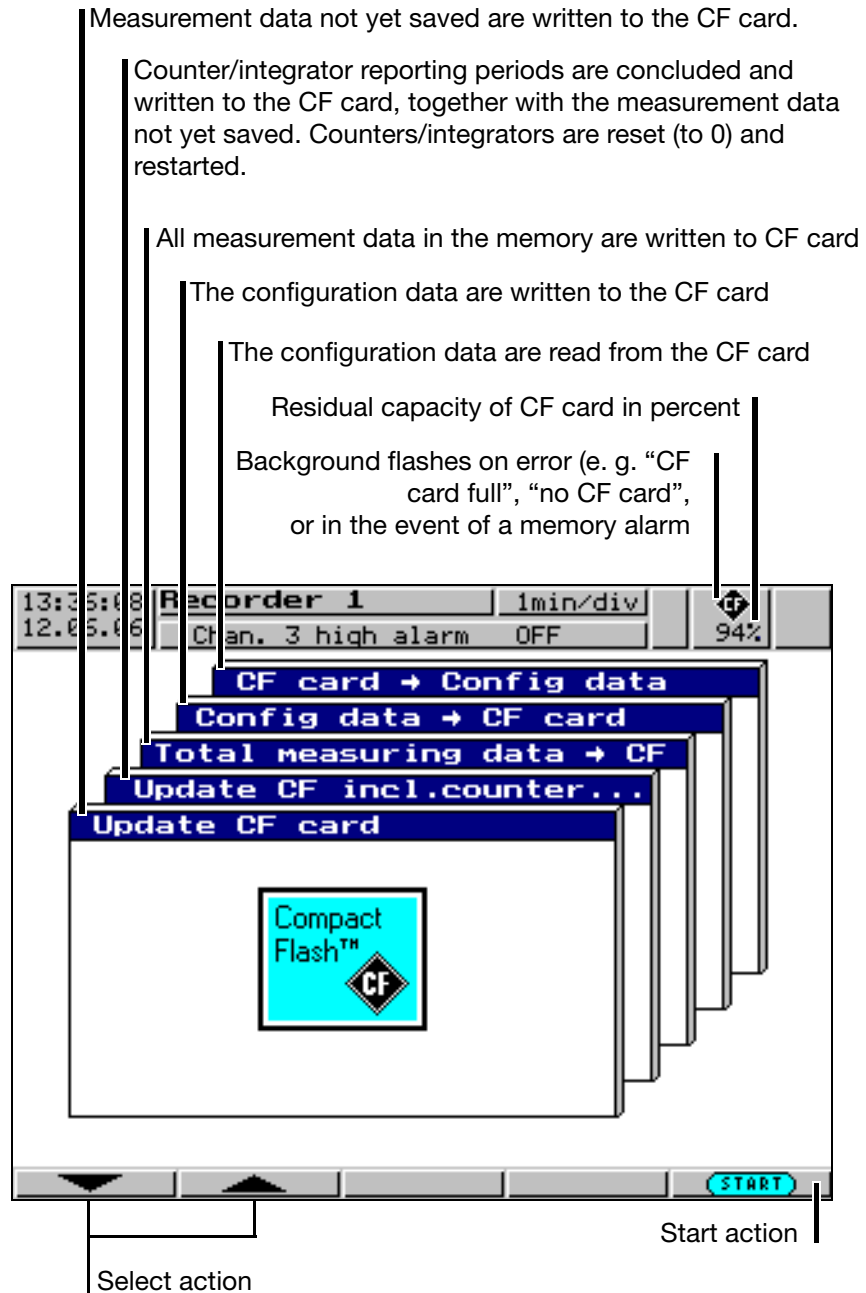

The function *CF card* → *Update* reads out data that have not been read out yet. After read-out, the data are marked as read in the recorder.

The function *Total meas. data* → *CF card* reads all the data from the internal memory, including those that had already been read out.

3 Operation and visualization

Status messages

Status messages from the CompactFlash manager are shown in the corresponding action window. The following status messages are possible:

Status message	Description
CF CARD UPDATED	Directly before removing the CF card from the instrument, it is necessary to call up <i>Update CF card</i> so that all measurement data up to the time of removal are contained on the CF card. The data not yet stored since the last automatic saving are written to the CF card.
NO CF CARD	If there is no CF card in the instrument, the CF card symbol flashes in the status line.
CF CARD FAULT	An error has occurred while writing to the CF card. The CF card is faulty. Remedy: Insert new (FAT16-formatted) CF card.
CF CARD FULL	If the CF card is full, the CF card symbol flashes in the status line. No more data will be written to the CF card. Remedy: Insert a blank CF card before the measurement data memory of the recorder is also full. If this is not done, measurement data will be lost.
NO CONFIG. FILE ON CF	An attempt was made to read a configuration from the CF card, but there is no suitable configuration file on the CF card.

3 Operation and visualization

3.7 Device info



The device info window displays general information about the instrument. It also includes the errors “Battery empty” and “Data lost”. If one of the instrument errors occur, the info symbol flashes in the status line.

**Basic menu →
Device info**

The device info is called up from the basic menu:

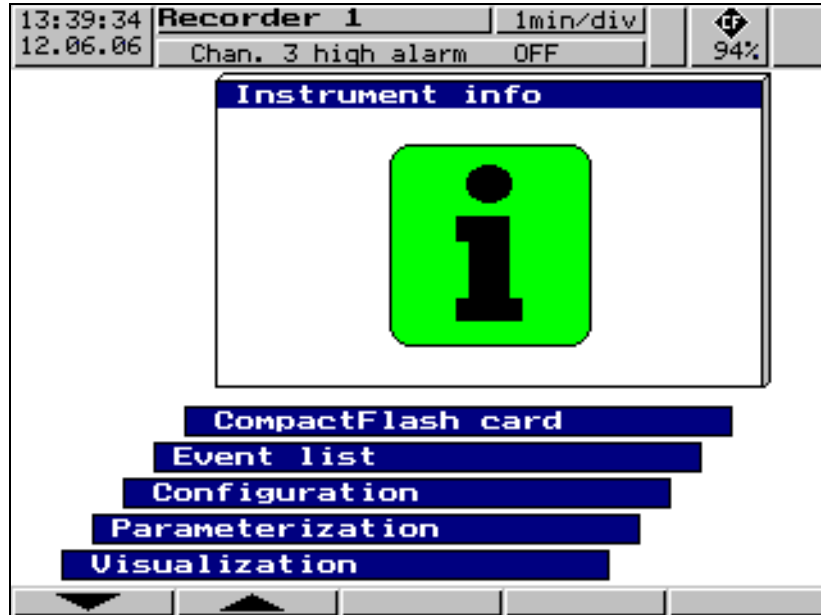

- * Select operating level *Device info*
- * Enter selection with E

Device info

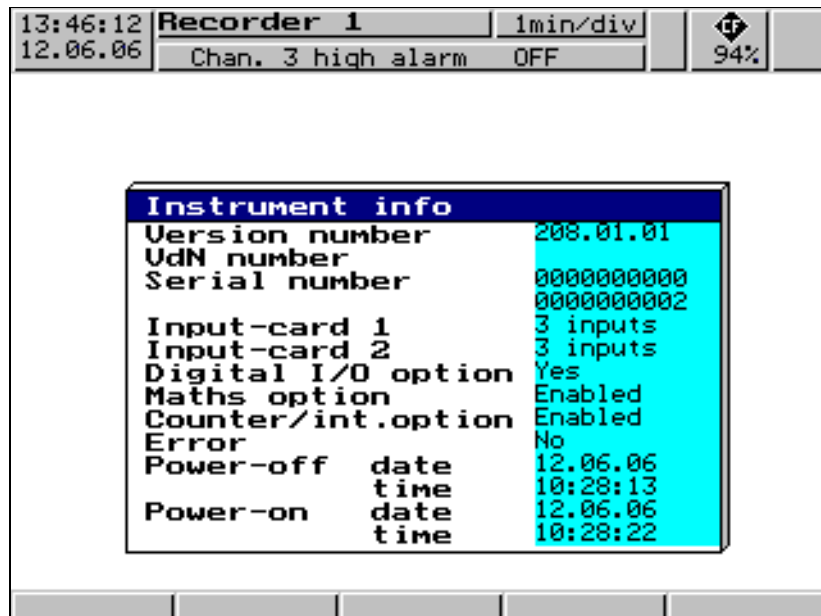

3 Operation and visualization

- This menu also includes the version number (e.g. 208.01.04). This is the version number of the device software. It is important because some functions are only available from a certain version number onwards.
- If the “Digital I/O option” is available (Yes), then the recorder also includes an RS232/RS485 interface.
- If the Ethernet interface is available, then the field “Vers. No. Ethernet” includes a number combination (e.g. 183.02.02). If this option is not available, the field is filled with “-”.

Error

The following errors may occur:

Error	Description
none	no error in instrument
Data lost	<p>A discharge of the battery or storage capacitor occurred during the last lengthy power interruption.</p> <p>The clock was set to 01.01.00 00:00:00.</p> <p>Remedy: Reset the time (⇒ Chapter 4.2.2 “Configuration - Instrument (device) data”) and use a new CF card for data storage.</p>
Battery empty	<p>This message appears on instruments with a lithium battery, when the time was reset after a loss of data but the battery is still empty</p> <p>Please return the instrument to the supplier for a change of battery.</p>



Data may be lost after separating the instrument from the supply: after more than 10 years (on instruments with a lithium battery) or after approx. 2 weeks (at ambient temperature 15 to 25 °C) with a storage capacitor.

3 Operation and visualization

3.8 Text entry

Entry options The configurable texts can be entered either through the setup program or on the instrument itself. This section describes the entry on the instrument.

Character selection The display below is shown when a text (e. g. *Configuration* → *Texts*) has been selected at the configuration level for editing using E.

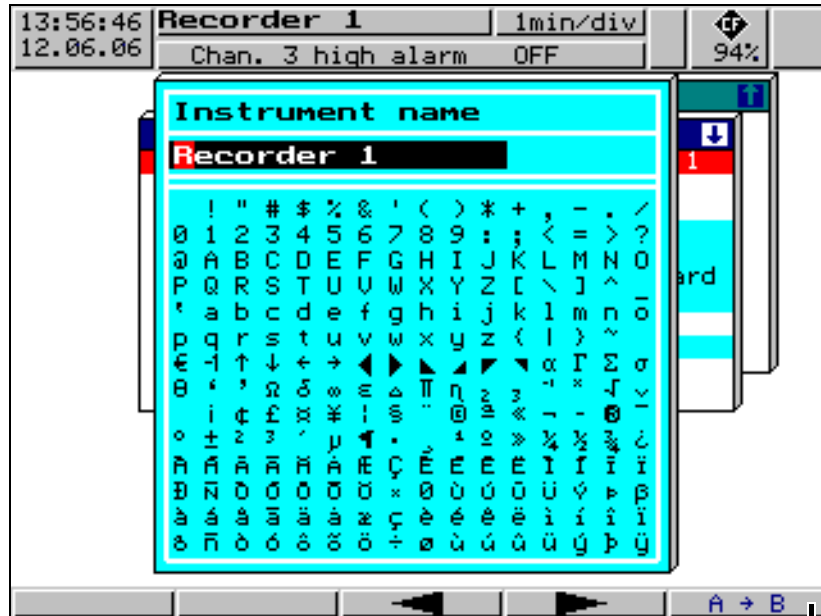

Select the character to be altered using the softkeys

Switch to character set matrix

After the character to be altered has been selected and the switch made to character set matrix, the cursor is positioned on the current character in the character set matrix.

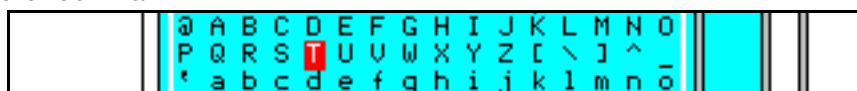

Character entry The softkeys change their function, as can be seen from the picture below:

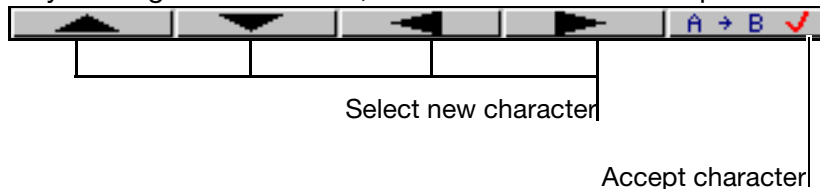

After the entire text has been entered, it can either be accepted or all alterations canceled.

- * Enter text with E
- or
- * cancel text entry with D

3 Operation and visualization

3.9 Entering values

The softkeys are also used to enter values in the instrument – the example shows fine calibration being carried out.

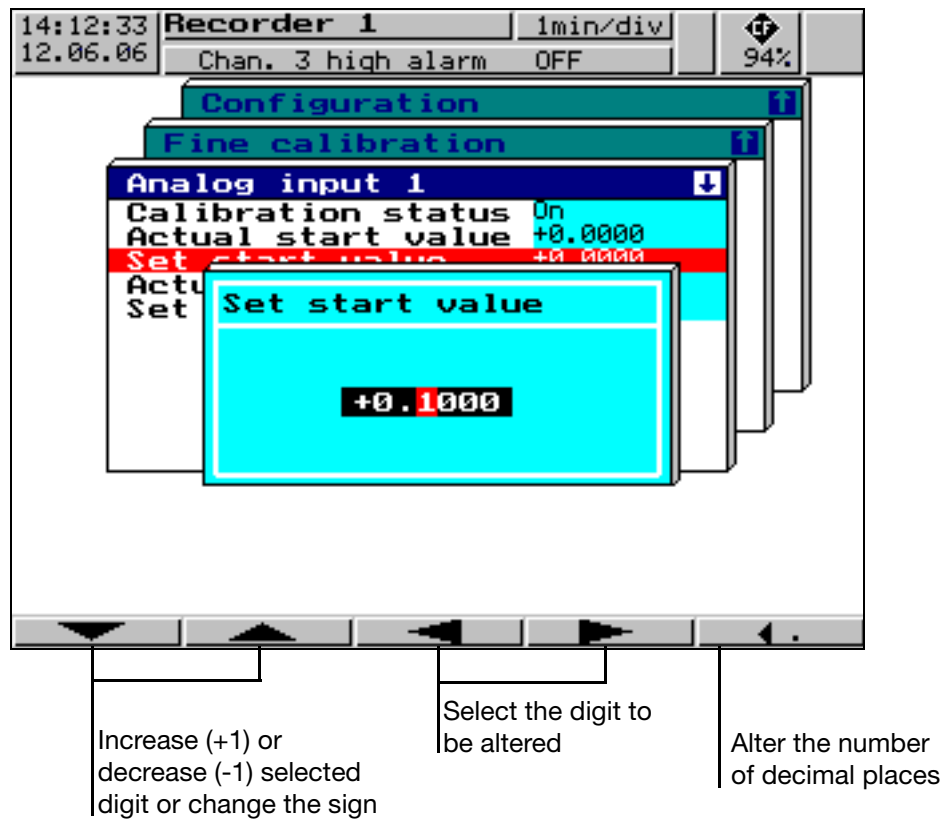

The sign can only be altered if the value is not "0". This means that you cannot start the value entry with an alteration of the sign if the current value is "0".

The entry can be concluded with E or canceled with D.

3 Operation and visualization

3.10 Code number (password query)

The following functions are protected ex-factory against unauthorized access by a password query:

- the *Configuration* menu
- parts of the *CompactFlash card* menu
- the *Parameterization* → *Reset counter / int.* menu.

The **factory default setting** for the passwords is **09200**.

You can also use a password to secure access to the recorder via one of the interfaces (with the exception of the setup interface). However, the factory default setting here is 0 (no password query). If you enter a value other than 0, please take into account that this number must also be sent to the recorder by an attached communications program.



Further information about the password query for the interfaces can be found in the Interface description 59482.

All passwords can be programmed differently (see Chapter 4.2.2 “Configuration - Instrument (device) data”).

Password query

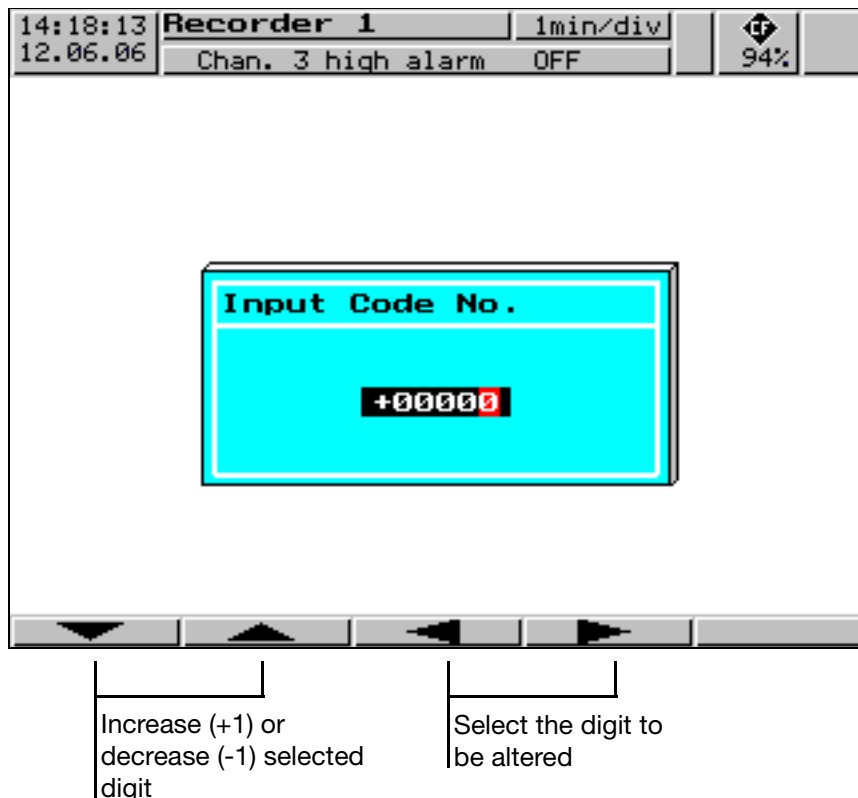

When you have finished the entry (e.g. +09200), use the E key to confirm it. Use D if you want to cancel the password query and quit the menu.

3 Operation and visualization

Password query
in the
configuration
menu

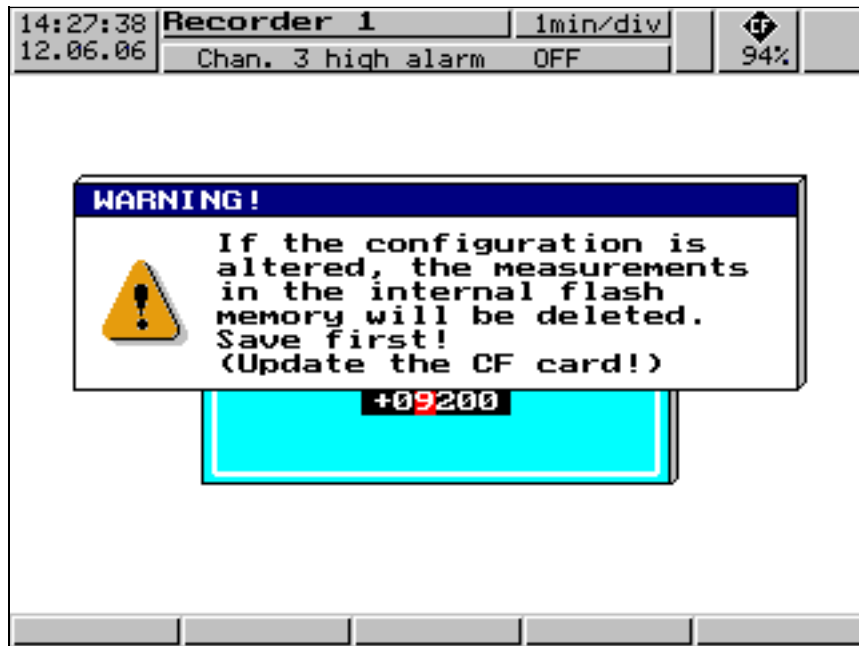

After the password has been entered in the *Configuration* menu, an additional security query will appear. You will only be able to gain access to the parameters when you have confirmed the the query with E.

4 Configuration parameters

4.1 Operating example

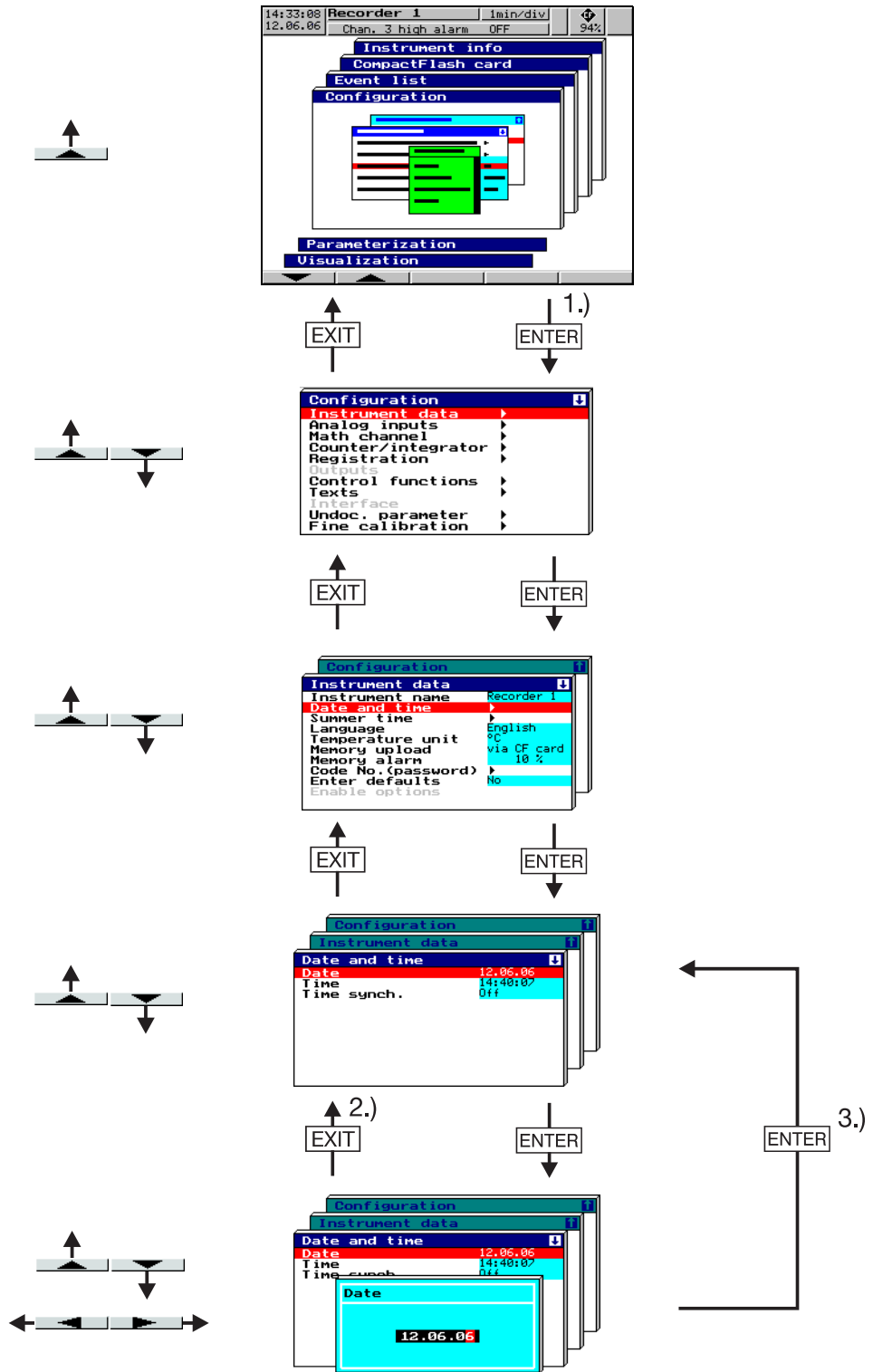

- 1 If required, the code number must be entered here (factory setting: 09200)
- 2 Cancel entry; the old settings are retained
- 3 Accept entry

4 Configuration parameters

4.2 Table of configuration parameters

The table below lists all the instrument parameters. The order in which the parameters are explained corresponds to the order in which they appear on the instrument (in the menu structure).

The first column describes the path to the particular parameter, via the menus and windows.

The second column lists the possible settings for the parameters or the possible selections. The factory default setting in this column is shown **bold**.

The third column contains a description of the parameter, or the possible selections, if the parameter and its function or selection is not self-evident.

4.2.1 Parameterization

	Parameter	Value/Selection	Description
Contrast	Parameterization → Contrast	0 – 16 – 31	Display contrast
Speed indication	Parameterization → Speed indic. mode	in mm/h, time/div , storage rate	The selected display mode is shown in the diagram representation
Switch-off event	Parameterization → Display off → Switch-off event	Waiting time , Cntrl signal	The type of display switch-off (screen saving) is selected here
Waiting time	Parameterization → Display off → Waiting time	0 – 32767 min	Time after which the display is switched off. Any key stroke will re-activate the display. The parameter can only be entered if the parameter <i>Switch-off event</i> is set to “Waiting time”. 0 = display not off
Control signal	Parameterization → Display off → Ctrl signal	Off , Bin. inp. 1 – 4, Logic channel 1 – 6, Low alarm 1 – 6, Low comb.al., High alarm 1 – 6, High comb.al., Count/Int/AI 1 – 6, C/i. comb.al., Comb. alarm, CF inserted, IntMemAlmCF, IntMemAlmSer, MemAlmCFcard, Error, Modbus flag,	If one of the 4 binary inputs (extra code) or one of the other control signals is set to “off” and activated, then the display will be switched off. The parameter can only be entered if the parameter <i>Switch-off event</i> is set to “Control signal”.
Signal type	Parameterization → Diagram view → Signal type	Analog inp. , Analog&Event	This determines which measurements are graphically displayed

4 Configuration parameters

	Parameter	Value/Selection	Description
Channel representation	Parameterization → Diagram view → Chan. represent.	Meas. small, Scaling Bar graph Meas. large, Off	This determines the contents of the channel line (header)
Channel indication	Parameterization → Diagram view → Channel indication → Channel 1 – 6	Yes, No	“Yes” means that the selected channels are shown in the header
Paper perforations	Parameterization → Diagram view → Paper perforations	No, Yes	“Yes” means that paper perforations are shown within the graphic display, on the left and right margins of the screen. Paper perforations can only be activated and shown if no event traces have been selected (signal type = analog input)
Counter/int. reset	Parameterization → Reset counter/int. → Channel 1 – 6	-999999999 to 0 to +999999999	The start value for the counter or integrator can be entered here. The current value is not saved. Count changes are documented in the event list. ⇒ Chapter 3.3 “Parameterization” If the password query is active (password “Reset counter/int.” > 0), the start values can only be set if the password has been entered correctly.

4 Configuration parameters

4.2.2 Configuration - Instrument (device) data

	Parameter	Value/Selection	Description
Device name	Configuration → Device data → Device name	16 characters	
Date	Configuration → Device data → Date and time → Date	any date	Entry of the current date
Time	Configuration → Device data → Date and time → Time	any time	Entry of the current time
Time synchronization	Configuration → Device data → Date and time → Time synchroniz.	Off , Bin. inp. 1 – 4, Logic channel 1 – 6, Low alarm 1 – 6, Low comb.al., High alarm 1 – 6, High comb.al., Count/Int/AI 1 – 6, C/i. comb.al., Comb. alarm, CF inserted, IntMemAlmCF, IntMemAlmSer, MemAlmCFcard, Error, Modbus flag,	With the help of this parameter (function), the system clocks of several paperless recorders can be simultaneously synchronized. When a binary input has been selected and is activated (transition from “Low” to “High”), then the time can be synchronized. The seconds are decisive in the time change. They are used for rounding the time up or down. Example: 12:55:29 -> 12:55:00 12:55:30 -> 12:56:00
Summer time (switch)	Configuration → Device data → Summer time → Switch	Off, User timed, Automatic	Automatic: 2:00 hrs or 3:00 hrs on the last Sunday in March or October
Summer time (start date)	Configuration → Device data → Summer time → Start date	any date	Can only be set if switch is set to user timed
Summer time (start time)	Configuration → Device data → Summer time → Start time	any time	Can only be set if switch is set to user timed
Summer time (end date)	Configuration → Device data → Summer time → End date	any date	Can only be set if switch is set to user timed
Summer time (end time)	Configuration → Device data → Summer time → End time	any time	Can only be set if switch is set to user timed

4 Configuration parameters

	Parameter	Value/Selection	Description
Language	Configuration → Device data → Language	German , English, French, Dutch, Spanish, Italian, Hungarian, Czech, Swedish, Polish, Danish, Finnish, Portuguese, Russian	
Temperature unit	Configuration → Device data → Temperature unit	°C, °F	
Memory upload	Configuration → Device data → Memory upload	via CF card , via RSxxx	You can determine how data are mainly to be uploaded. The value for the available capacity (shown in the status line) will vary according to the selection.
Memory alarm	Configuration → Device data → Memory alarm	0 – 10 – 100%	The signals “IntMemAlmCF”, “IntMemAlmInterf” and “MemAlmCFcard” are activated when the residual capacity of the internal memory or the CF card has fallen to this value. Chapter 2.4 “Digital signals (event traces)”
Code number for the configuration	Configuration → Device data → Code No. (password) → Configuration	00000 – 09200 – 09999	Code number for configuration level; 0000 = off The data saved in the FLASH memory will be deleted when the configuration is changed.
Code number: CompactFlash card menu (CF code No.)	Configuration → Device data → Code No. (password) → CF manager	00000 – 09200 – 09999	Code number for menu functions CompactFlash card; 0000 = off
Code number: Reset counter/int.	Configuration → Device data → Code No. (password) → Reset counter/int.	00000 – 09200 – 09999	Code number to delete individual counts; 0000 = off
Code number: RS232/RS485 + Ethernet	Configuration → Device data → Code No. (password) → RS232/RS485+ Ethernet	00000 – 09999	Code number as protection against unauthorized access to data via one of the interfaces; 0000 = off
Factory setting	Configuration → Device data → Enter defaults	No , Yes	Yes = enter factory default setting (after entry, the parameter automatically returns to No)

4 Configuration parameters

	Parameter	Value/Selection	Description
Enable options	Configuration → Device data → Enable options		This parameter is used to enable additional functions, e.g. the math/ logic module and counter/ integrator. The parameter will not be available if all the recorder functions have been enabled.
Enable options: Computed code No.	Configuration → Device data → Enable options → Computed code No.	(display a code No.)	The value that is shown here must be passed on to the manufacturer. The manufacturer will then send you the release code.
Enable options: Authorization code	Configuration → Device data → Enable options → Authorization code	Authorization code entry	Enter the authorization code (release code) you received here.
Device-info text	In the setup program, the parameter <i>Configuration level</i> → <i>Device data</i> can be used to enter a device-Info text (max. 500 characters). The text is saved together with the measurement data, and can be displayed in the PCA3000 evaluation software. The text will not be shown on the instrument.		

4.2.3 Configuration - Analog inputs

	Parameter	Value/Selection	Description
Sensor	Configuration → Analog inputs → Analog input 1 – 6 → Sensor	Off, RTD, Thermocouple, Current , Voltage	Depending on the sensor that was selected, only the relevant parameters can be selected when configuring the analog input.
Linearization	Configuration → Analog inputs → Analog input 1 – 6 → Linearization	Linear , Pt100, Pt100 JIS, Pt100 GOST, Pt500, Pt1000, Pt50, Ni100, Cu50, Cu100, Fe-Con J, NiCr-Con E, NiCr-Ni K, NiCrSi N, Cu-Con T, PtRh-PtRh B, PtRh-Pt R, PtRh-Pt S, Cu-Con U, Fe-Con L, W3W25Re D, W5W26Re C, ChromelCopel	
Connection circuit	Configuration → Analog inputs → Analog input 1 – 6 → Connection circuit	2 – 4 wire	Only for sensor type: resistance thermometer
Cold junction	Configuration → Analog inputs → Analog input 1 – 6 → Cold junction	Intern.Pt100 Extern. const	

4 Configuration parameters

	Parameter	Value/Selection	Description
External cold junction temperature	Configuration → Analog inputs → Analog input 1–6 → Ext. CJ temp.	-50 to +150°C	External cold junction temperature for thermocouples
Range start	Configuration → Analog inputs → Analog input 1–6 → Range start	any value 0mA	
Range end	Configuration → Analog inputs → Analog input 1–6 → Range end	any value 20mA	
Start temperature	Configuration → Analog inputs → Analog input 1–6 → Start temperature	any value	Only for sensor: current or voltage with linearization, resistance thermometer, thermocouple. Only for signals that have not yet been linearized.
End temperature	Configuration → Analog inputs → Analog input 1–6 → End temperature	any value	Only for sensor: current or voltage with linearization, resistance thermometer, thermocouple. Only for signals that have not yet been linearized.
Scaling start	Configuration → Analog inputs → Analog input 1–6 → Scaling start	-99999 to 0 to +99999	
Scaling end	Configuration → Analog inputs → Analog input 1–6 → Scaling end	-99999 to +100 to +99999	
Filter constant	Configuration → Analog inputs → Analog input 1–6 → Filter constant	0.0 – 0.1 – 10.0s	

4 Configuration parameters

4.2.4 Configuration - Math channels

	Parameter	Value/Selection	Description
Scaling start	Configuration → Math channels → Math channel 1 – 6 → Scaling start	-99999 to 0 to +99999	Scaling start of a math channel. The setup program is used to determine what is involved in a math channel.
Scaling end	Configuration → Math channels → Math channel 1 – 6 → Scaling end	-99999 to +100 to +99999	Scaling end of a math channel. The setup program is used to determine what is involved in a math channel.

4.2.5 Configuration - Counter/integrator (extra code)

	Parameter	Value/Selection	Description
Channel	Configuration → Counter/integrator → Counter/int.chans.	1 – 6	Select channel for which the subsequent parameters are to be configured.
Function	Configuration → Counter/integrator → Counter/int.chans. → Channel 1 – 6 → Function	Off , Counter Integrator, Oper.time	First select the required function. ⇒ Chapter 2.5 “Counters / integrators / operating time counter”
Type	Configuration → Counter/integrator → Counter/int.chans. → Channel 1 – 6 → Type	Periodic, External, Daily , Weekly, Monthly, Aearly, Total, DailyFrom-To	Reporting period. Select here when the count value is to be stored and reset.
Input signal	Configuration → Counter/integrator → Counter/int.chans. → Channel – 6 → Input signal	Off , Bin. inp. 1 – 4, Logic channel 1 – 6, Low alarm 1 – 6, Low comb.al., High alarm 1 – 6, High comb.al., Count/Int/Al 1 – 6, C/i. comb.al., Comb. alarm, CF inserted, IntMemAlmCF, IntMemAlmSer, MemAlmCFcard, Error, Modbus flag,	The parameter can only be programmed if “Counter” or “Operating time” has been selected under <i>Function</i> . Please select which event is to be counted.

4 Configuration parameters

	Parameter	Value/Selection	Description
Input signal	Configuration → Counter/integrator → Counter/int.chans. → Channel 1 – 6 → Input signal	Analog inp. 1 – 3(6), Math channel 1 – 6	The parameter can only be programmed if “Integrator” has been selected under <i>Function</i> . Please select which input is to be integrated.
Weighting	Configuration → Counter/integrator → Counter/int.chans. → Channel 1 – 6 → Weighting	-99999 to +1 to +99999	Select the weighting factor here. If, for instance, 0.001 is entered, then a conversion can be achieved from liter/sec to m ³ . If a negative weighting factor is entered (e.g. -1), the counter will count down.
Time base	Configuration → Counter/integrator → Counter/int.chans. → Channel 1 – 6 → Time base	Second, Minute, Hour, Day	The parameter can only be programmed if “Integrator” or “Operating time” has been selected under <i>Function</i> . Integrator: Select the time base for integrating the selected channel (second, for example, if your sensor generates a signal in liters/second). Operating time: Select the unit used for counting the time.
Threshold value	Configuration → Counter/integrator → Counter/int.chans. → Channel 1 – 6 → Threshold value	0 – 99999	The parameter can only be programmed if “Integrator” has been selected under <i>Function</i> . Enter the threshold value that has to be exceeded for integration to proceed.
Channel name (line 1)	Configuration → Counter/integrator → Counter/int.chans. → Channel 1 – 6 → Channel name	12 characters Counter/int.	The text that has been entered appears together with line 2 and the current count on the recorder screen (visualization and event list). ⇒ Chapter 3.2.7 “Counters / integrators / operating time”
Channel name (line 2)	Configuration → Counter/integrator → Counter/int.chans. → Channel 1 – 6 → Channel name	12 characters Channel 1 – 6	The text that has been entered appears together with line 1 and the current count on the recorder screen (visualization and event list).

4 Configuration parameters

	Parameter	Value/Selection	Description
Unit	Configuration → Counter/integrator → Counter/int.chans. → Channel 1 – 6 → Unit	5 characters	Enter the unit which is displayed on the recorder screen, together with the entered text and the current count.
Decimal place	Configuration → Counter/integrator → Counter/int.chans. → Channel 1 – 6 → Decimal place	Automatic, X.XXXX, XX.XXX, XXX.XX, XXXX.X, XXXXX.	Specify the decimal place for displaying the count on the recorder screen.
Counter text	Configuration → Counter/integrator → Counter/int.chans. → Channel 1 – 6 → Counter text	Standard text, Text 1 – 18, No text	The text selected here will appear in the status line and the event list if the counter is incremented (decremented).
Alarm	Configuration → Counter/integrator → Counter/int.chans. → Channel 1 – 6 → Alarm → Alarm	Off, Activated	
Limit value	Configuration → Counter/integrator → Counter/int.chans. → Channel 1 – 6 → Alarm → Limit	-99999 to 100 to +99999	An alarm is triggered when the limit is infringed. Using the parameter <i>Weighting</i> , it is possible to differentiate between going above or below the limit (positive weighting factor = alarm on going above the limit)
Alarm text	Configuration → Counter/integrator → Counter/int.chans. → Channel 1 – 6 → Alarm → Alarm text	Standard text, Text 1 – 18, No text	On going above/below the limit, the text selected here will appear in the status line and the event list.
Synchroniz. time	Configuration → Counter/integrator → Synchronizat. time	any time (00:00:00)	Please enter the time at which the daily, weekly, monthly or yearly counter/integrator value is to be saved.
Period	Configuration → Counter/integrator → Period	1 min, 2min , 3min, 4min, 5min, 10min, 15min, 30min, 1h, 2h, 3h, 4h, 6h, 8h, 12h	Only programmable, if the parameter <i>Type</i> is set to “periodic” on at least one counter/integrator. The counter/integrator values are saved at the selected interval.

4 Configuration parameters

	Parameter	Value/Selection	Description
Ext. Ctrl signal	Configuration → Counter/integrator → Ext. ctrl signal	Bin. inp. 1 – 4, Logic channel 1 – 6, Low alarm 1 – 6, Low comb.al., High alarm 1 – 6, High comb.al., Count/Int/AI 1 – 6, C/i. comb.al., Comb. alarm, CF inserted, IntMemAlmCF, IntMemAlmSer, MemAlmCFcard , Error, Modbus flag,	Only programmable, if the parameter <i>Type</i> is set to “external” on at least one counter/integrator. Summation of the counter/integrator values will only take place if the selected digital signal is set to “1”. When changing to “0”, the values will be saved and reset.
Weekday	Configuration → Counter/integrator → Weekday	Monday , Tuesday, Wednesday, Thursday, Friday, Saturday, Sunday	Only programmable, if the parameter <i>Type</i> is set to “Weekly” on at least one counter/integrator. The counter/integrator values are saved on the selected day on reaching the synchronizing time.
Daily start time	Configuration → Counter/integrator → Daily start time	any time (06:00:00)	Only programmable, if the parameter <i>Type</i> is set to “Daily from-to” on at least one counter/integrator.
Daily end time	Configuration → Counter/integrator → Daily end time	any time (18:00:00)	Only programmable, if the parameter <i>Type</i> is set to “Daily from-to” on at least one counter/integrator.
Generate reset	Configuration → Counter/integrator → Generate reset	Off , Bin. inp. 1 – 4, Logic channel 1 – 6, Low alarm 1 – 6, Low com.al., High alarm 1 – 6, High comb.al., Count/Int/AI 1 – 6, C/i. comb.al., Comb. alarm, CF inserted, IntMemAlmCF, IntMemAlmSer, MemAlmCFcard, Error, Modbus flag,	Here you can determine the event which will reset all counter and integrator counts (without saving). ⇒ Page 19 “External reset”

4 Configuration parameters

4.2.6 Configuration - Recording

	Parameter	Value/Selection	Description
	Analog channels		
Input signal	Configuration → Recording → Analog channels → Analog channel 1 – 6 → Input signal	Analog input 1 – 6, Math channel 1 – 6	Select which channel is to be recorded (stored).
Channel name	Configuration → Recording → Analog channels → Analog channel 1 – 6 → Channel name	16 characters Analog channel 1 – 6	The channel name is shown in the channel line (header) for bar graph and scaling.
Unit	Configuration → Recording → Analog channels → Analog channel 1 – 6 → Unit	5 characters %	
Decimal place	Configuration → Recording → Analog channels → Analog channel 1 – 6 → Decimal place	Automatic, X.XXXX, XX.XXX, XXX.XX, XXXX.X, XXXXX.	Automatic: representation with maximum resolution
Line width	Configuration → Recording → Analog channels → Analog channel 1 – 6 → Line width	Thin, Thick	Line width of the measurement curve within the graphical display
Alarm	Configuration → Recording → Analog channels → Analog channel 1 – 6 → Alarm → Alarm	Off, Activated	
Low limit	Configuration → Recording → Analog channels → Analog channel 1 – 6 → Alarm → Low limit	-99999 to 0 to +99999	
High limit	Configuration → Recording → Analog channels → Analog channel 1 – 6 → Alarm → High limit	-99999 to 0 to +99999	

4 Configuration parameters

	Parameter	Value/Selection	Description
Differential	Configuration → Recording → Analog channels → Analog channel 1 – 6 → Alarm → Differential	-99999 to 0 to +99999	
	(1) = Low limit (2) = High limit (3) = Differential		
Text Low alarm	Configuration → Recording → Analog channels → Analog channel 1 – 6 → Alarm → Text Low alarm	Standard text, Text 1 – 18, No text	⇒ Chapter 3.5 “Event list” ⇒ Configuration → Texts, Page 74
Text High alarm	Configuration → Recording → Analog channels → Analog channel 1 – 6 → Alarms → Text High alarm	Standard text, Text 1 – 18, No text	
Alarm delay	Configuration → Recording → Analog channels → Analog channel 1 – 6 → Alarms → Alarm delay	0 – 32767s	Alarm delay is activated at a value > 0. When activated, an alarm will only be generated when it has been present for at least as long as it takes for the set time to elapse.

4 Configuration parameters

	Parameter	Value/Selection	Description
	Event traces		
Input signal	Configuration → Recording → Event traces → Event traces 1 – 6 → Input signal	Off, Bin. inp. 1 – 4 , Logic channel 1 – 6, Low alarm 1 – 6, Low comb.al., High alarm 1 – 6, High comb.al., Count/Int/AI 1 – 6, C/i. comb.al., Comb. alarm, CF inserted, IntMemAlmCF, IntMemAlmSer, MemAlmCFcard, Error, Modbus flag,	The event (digital signal) which is to be recorded is assigned to an event trace here. Event traces 5 and 6 are switched off in the factory setting.
Trace designation	Configuration → Recording → Event traces → Event traces 1 – 4 → Trace design.	7 characters BE 1 – 4	
	Operating modes		
Memory status: Normal operation	Configuration → Recording → Normal operation → Memory status	Off, On	
Stored value: Normal operation	Configuration → Recording → Normal operation → Stored value	Average val., Instant val., Minimum, Maximum, Peak value	⇨ Chapter 2.7 “Operating modes” Chapter 2.8 “Storing data”
Storage cycle: Normal operation	Configuration → Recording → Normal operation → Storage cycle	1 – 60 – 32767s	⇨ Chapter 2.7 “Operating modes” Chapter 2.8 “Storing data”
Start time: Timed operation	Configuration → Recording → Timed operation → Start time	any time	Off when Start time = End time
End time: Timed operation	Configuration → Recording → Timed operation → End time	any time	
Stored value: Timed operation	Configuration → Recording → Timed operation → Stored value	Average val., Instant val., Minimum, Maximum, Peak value	⇨ Chapter 2.7 “Operating modes” Chapter 2.8 “Storing data”

4 Configuration parameters

	Parameter	Value/Selection	Description
Storage cycle: Timed operation	Configuration → Recording → Timed operation → Storage cycle	1 – 5 – 32767 s	⇒ Chapter 2.7 “Operating modes” Chapter 2.8 “Storing data”
Control signal: Event operation	Configuration → Recording → Event operation → Control signal	Off , Bin. inp. 1 – 4, Logic channel 1 – 6, Low alarm 1 – 6, Low comb.al., High alarm 1 – 6, High comb.al., Count/Int/AI 1 – 6, C/i. comb.al., Comb. alarm, CF inserted, IntMemAlmCF, IntMemAlmSer, MemAlmCFcard, Error, Modbus flag,	If the configured signal is active, the instrument will switch to event operation.
Stored value: Event operation	Configuration → Recording → Event operation → Stored value	Average val., Instant val., Minimum, Maximum, Peak value	⇒ Chapter 2.7 “Operating modes” Chapter 2.8 “Storing data”
Storage cycle: Event operation	Configuration → Recording → Event operation → Storage cycle	1 – 5 – 32767 s	⇒ Chapter 2.7 “Operating modes” Chapter 2.8 “Storing data”

4.2.7 Configuration - Outputs (extra code)

	Parameter	Value/Selection	Description
Action of outputs	Configuration → Outputs → Relay K1 – K3, → Action	Off, make (SPST-NO), break (SPST-NC)	As standard, relay K1 is configured as break (SPST-NO), K2 and K3 are inactive.
Control signal: Outputs	Configuration → Outputs → Relay K1 – K3, → Control signal	Off, Bin. inp. 1 – 4, Logic channel 1 – 6, Low alarm 1 – 6, Low comb.al., High alarm 1 – 6, High comb.al., Count/Int/AI 1 – 6, C/i. comb.al., Comb. alarm, CF inserted, IntMemAlmCF, IntMemAlmSer, MemAlmCFcard, Error, Modbus flag	The configured signal is output to the relay. The default setting for K1 is <i>Error</i> .

4 Configuration parameters

4.2.8 Configuration - Control functions

	Parameter	Value/Selection	Description
External texts: Binary input 1 – 4	Configuration → Control functions → External texts → Binary input 1 ... 4	Standard text, Text 1 – 18, No text	⇒ Chapter 3.5 “Event list” ⇒ Chapter 4.2.9 “Configuration - Texts”
External texts: Logic channel 1 – 6	Configuration → Control functions → External texts → Logic channel 1 – 6	Standard text, Text 1 – 18, No text	Can only be used if the “Math/logic module” option is available. ⇒ Chapter 3.5 “Event list” ⇒ Chapter 4.2.9 “Configuration - Texts”
Key inhibit	Configuration → Control functions → Key inhibit	Off , Bin. inp. 1 – 4, Logic channel 1 – 6, Low alarm 1 – 6, Low comb.al., High alarm 1 – 6, High comb.al., Count/Int/Al 1 – 6, C/i. comb.al., Comb. alarm, CF inserted, IntMemAlmCF, IntMemAlmSer, MemAlmCFcard, Error, Modbus flag,	The keys will be locked as soon as the selected signal is activated

4.2.9 Configuration - Texts

	Parameter	Value/Selection	Description
Texts	Configuration → Texts → Text1 – 18	20 characters Text 1 – 18	

4 Configuration parameters

4.2.10 Configuration - Interfaces

	Parameter	Value/Selection	Description
Serial interface			
Interface type	Configuration → Interfaces → RS232/RS485 → Interface type	RS232, RS485	Parameters for the serial interface (extra code)
Protocol	Configuration → Interfaces → RS232/RS485 → Protocol	MODbus , Jbus	
Baud rate	Configuration → Interfaces → RS232/RS485 → Baud rate	9600 bps, 19200 bps, 38400 bps	
Data format	Configuration → Interfaces → RS232/RS485 → Data format	8-1-none , 8-1-odd, 8-1-even, 8-2-none	
Device address	Configuration → Interfaces → RS232/RS485 → Device address	1 – 254	
Min. response time	Configuration → Interfaces → RS232/RS485 → Min. response time	0 – 500ms	
Ethernet interface			
IP address	Configuration → Interfaces → Ethernet → IP address	000.000.000.000 ... 192.168.000.010 ... 255.255.255.255	The IP address for the recorder is set here.
Subnet mask	Configuration → Interfaces → Ethernet → Subnet mask	000.000.000.000 ... 255.255.000.000 ... 255.255.255.255	The subnet mask is set here. Devices are combined into subnets through the subnet mask. All devices whose IP address, when AND-linked, is identical to the subnet mask, belong to one subnet and can thus communicate with each other.
Gateway	Configuration → Interfaces → Ethernet → Gateway	000.000.000.000 ... 255.255.255.255	The address for the standard gateway is set here. Devices that do not belong to a subnet can communicate through the standard gateway.

4 Configuration parameters

4.2.11 Configuration - Undocumented parameters

	Parameter	Value/Selection	Description
Undocumented parameter 1 – 40	Configuration → Undoc. parameter → Par. 1 – 40		These parameters are intended for customer-specific adaptation. Alteration to the settings may only be carried on the express instruction of the equipment manufacturer.

4.2.12 Configuration - Fine calibration

	Parameter	Value/Selection	Description
Calibration status	Configuration → Fine calibration → Analog input 1 – 6 → Calibration status	Off , On	A calibration (adjustment) of the analog measurements can be activated here. The adjustment is carried out using a linear equation.
Actual start value	Configuration → Fine calibration → Analog input 1 – 6 → Actual start value	-99999 to 0 to +99999	Start value for actual line. Only active when calibration status = On.
Set start value	Configuration → Fine calibration → Analog input 1 – 6 → Set start value	-99999 to 0 to +99999	Start value for target line. Only active when calibration status = On.
Actual end value	Configuration → Fine calibration → Analog input 1 – 6 → Actual end value	-99999 to 1000 to +99999	End value for actual line. Only active when calibration status = On.
Set end value	Configuration → Fine calibration → Analog input 1 – 6 → Set end value	-99999 to 1000 to +99999	End value for target line. Only active when calibration status = On.



Systematic errors, such as those caused by an unsuitable probe mounting, for example, can be compensated through fine calibration.

Example:

A sensor covers temperatures from 200 to 300 °C.

It is built into a tunnel oven so unfavorably that it always indicates 10 °C less than the temperature of the oven contents. The incorrect measurement can be corrected through fine calibration.

Actual start value : 200 °C
 Set start value : 210 °C
 Actual end value : 300 °C
 Set end value : 310 °C

The setup program is used for the easy creation of configuration files, and to configure the instruments from a PC.

5.1 Hardware and software requirements

The following hardware and software requirements have to be met for installing and operating the setup program:

Minimum configuration

- Intel Pentium¹ III or higher,
- Microsoft Windows² NT4.0 (SP6a), 2000 or XP,
- 128Mbyte main memory,
- CD drive,
- mouse,
- one free serial interface or network connection, or CompactFlash memory cards (depending on the type of data transmission to the paperless recorder), and
- 120Mbyte available on hard disk.

In addition, the following items are required for communication between the PC and the recorder, such as:

- reader/writer for CompactFlash memory card or
- PC interface cable including adapter (only when using the setup interface) or
- serial interface cable (when using the RS232 or RS485 interface) or
- network connection (when using the Ethernet connection).

Recommended configuration

- Intel Pentium 4
- Windows XP or 2000
- 512Mbyte main memory
- 2Gbyte free space on hard disk for data

¹ Intel and Pentium are registered trademarks of Intel Corporation

² Microsoft and Windows are registered trademarks of Microsoft Corporation

5 Setup program

5.2 Installation

Run the installation program

- * Start Microsoft Windows



If Microsoft Windows has already been started, all Windows programs must be shut down before installing the setup program.

- * Insert the CD into the drive, then close the drive.

After the CD has been inserted, the installation program will start automatically. If not, proceed as follows:

- * Start the file "Launch.exe" in the main directory of the CD.

The installation program will lead you through the rest of the installation with screen messages.



If no valid license number is entered during the installation, the setup program will remain fully functional for 30 days. After this time, the data transmission, data storage and printout functions will be disabled.

Program start

- * Start the setup program by selecting the entry "Setup program ..." in the chosen program folder.

When the software has just been installed for the first time, there will not yet be a query of the user name and password. In the menu *Extras*, the query at the start of the program can be activated by the function *Renew log-in / Alter password*.

The activation of the log-in function can be used to distinguish between the user types "Specialist" and "Maintenance". These two users have different access rights with regard to the functions in the setup program.

⇒ "Renew log-in / Alter password" on page 101

⇒ Chapter 6 "Rights"

If the query is active, proceed as follows:

- * Log in.

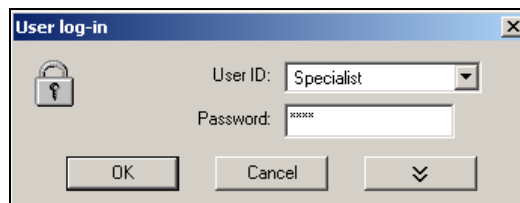

Please note that not all functions are available to all users.

5.3 User interface

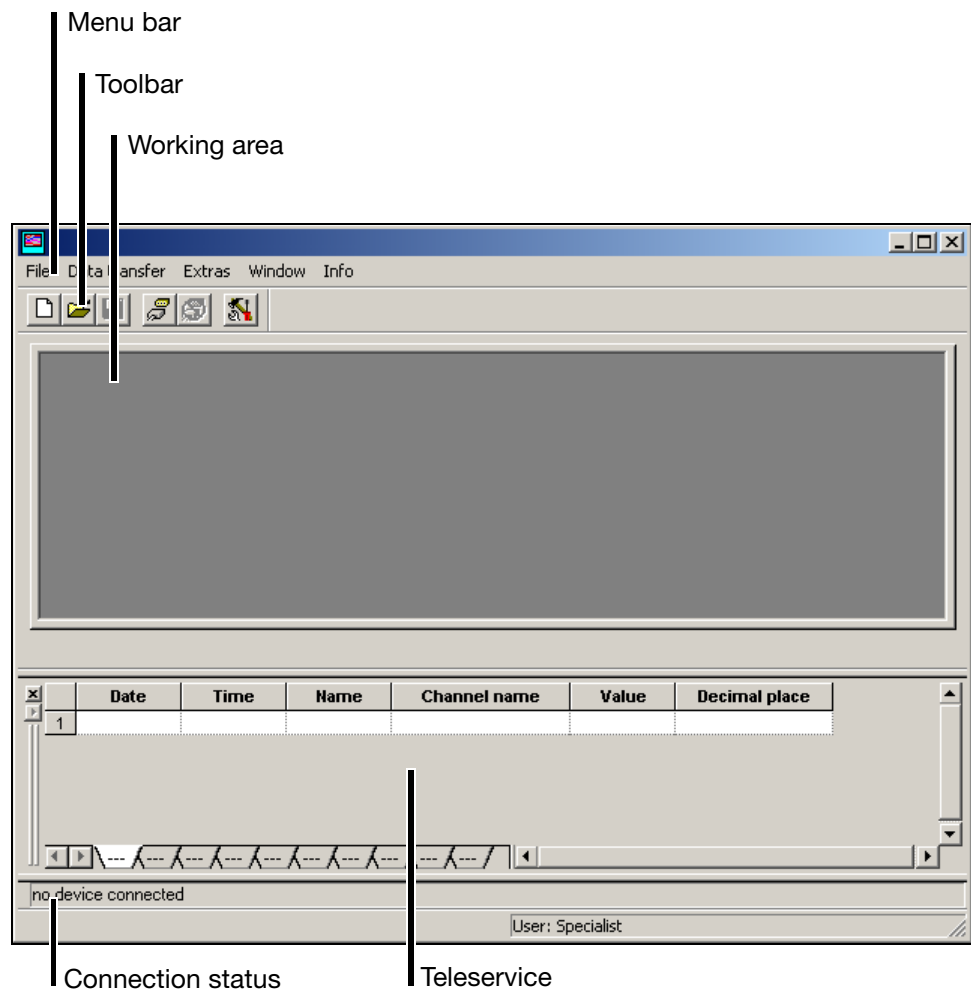

Menu bar

The individual functions of the setup program can be started by using the menu bar.

⇒ Chapter 5.8 “Menu functions”

Toolbar

The toolbar contains selected functions of the menu bar. They can be started from the left mouse button. If you rest the mouse pointer on one of the icons (tool tips), you will see the function title after a short delay.

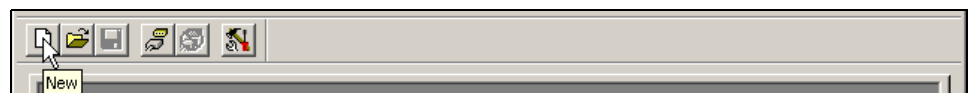

5 Setup program

Shifting the toolbar

The position of the toolbar can be changed, if desired.

- * Move the mouse pointer between two icon groups.



- * Press the left mouse button.
- * Keeping the left mouse button pressed, drag the toolbar to the required position.
- * Now release the mouse button.



Possible positions are:

- the left or right window border (vertical orientation),
- below the menu bar (horizontal orientation),
- at the bottom edge, above the user details (horizontal orientation) or
- any position (in own window - horizontal orientation).

Working area

Here you are provided with an overview of the current settings of a configuration file.

⇒ Chapter 5.4 “Configuration”

Connection status

In the “Connection status” line you can check whether a connection to a device has been established, and which interface data are being used. The line can be made visible or hidden through *Window* → *Connection status*.

Example: No connection



Example: Connection to a device



The line can be moved (like the toolbar). In order for the shift to work, first position the mouse pointer on the position shown below, before you press the left mouse button.

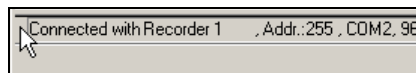

Teleservice

Using Teleservice, you can view the latest data from the paperless recorder and alter the Modbus flag. Teleservice can be made visible or hidden through the function *Window* → *Teleservice*.

⇒ Chapter 5.5 “Teleservice”

5.4 Configuration

By using the function *File* → *New* (or *File* → *Open*) you can create a new configuration file (setup) or open an already existing one. The working area will be filled with the corresponding settings.

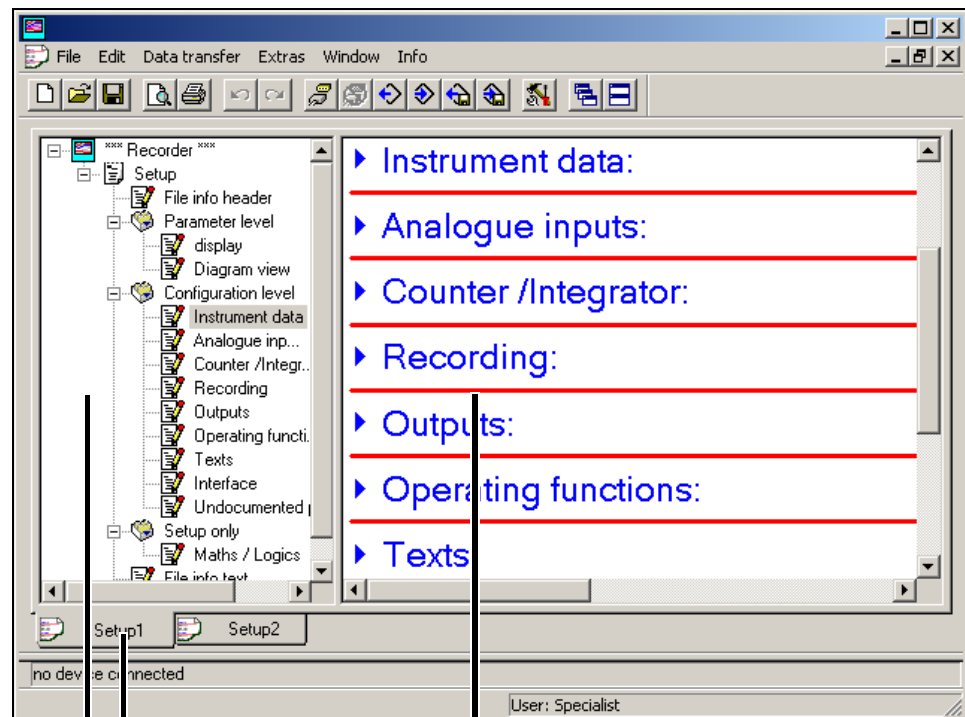

Current setup

Navigation tree
for finding the settings
quickly

Dialog window
The settings are displayed here.

Navigation tree A single click with the left mouse button in the navigation tree will position the entry visibly in the dialog window.

Clicking on will reduce the size of the display, one click on will enlarge the display again.

A double-click on an entry (e.g. Instrument data) will start the change dialog. Alternatively, a change can also be started via the menu bar (*Edit* → *Configuration level* → *Device data*).

Dialog window By double-clicking on an entry in the dialog window, you can start the change dialog. One click on “Arrow to right” (▶) before the entry will list the current setting in the dialog window, one click on “Arrow down” (▼) will hide the current setting again.

Current setup If several setup settings are open at the same time, just one simple click on the name and ...

5 Setup program

... the window becomes an active window.

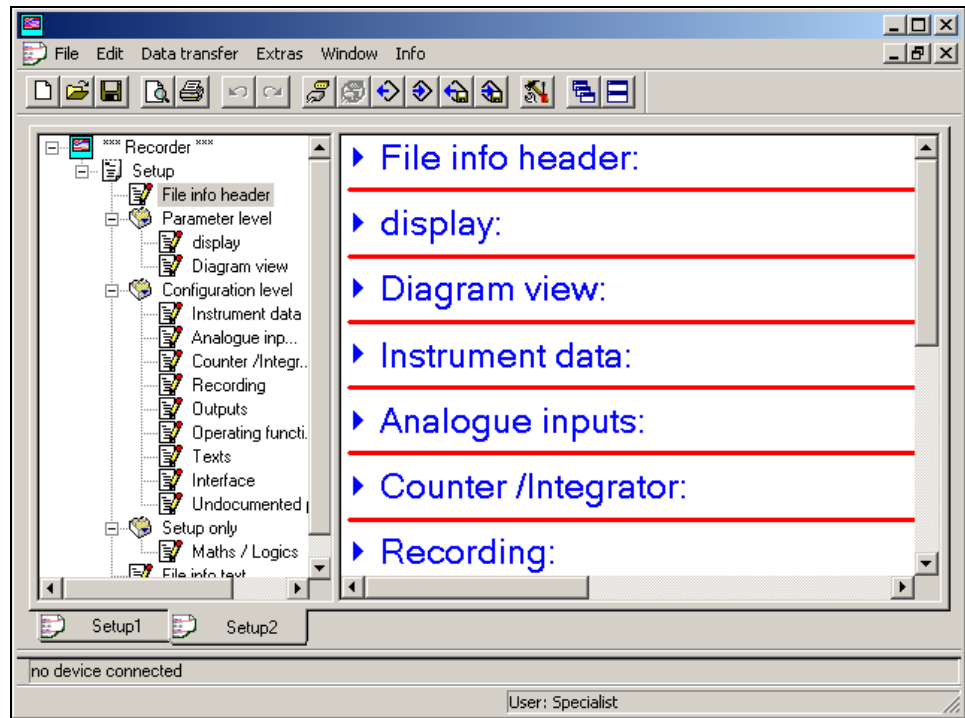

Functions of the right mouse button

If you use the right mouse button in the dialog window, different functions will be available. These functions concern that part of the configuration on which the mouse pointer was positioned when the right mouse button was pressed.

Example:

The right mouse button was pressed when it was on the entry “Analog inputs”.

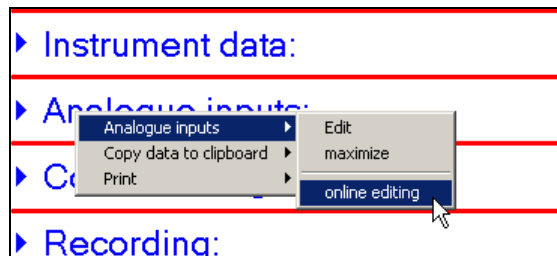

Analog inputs → Edit

This function starts the change dialog for configuring the analog inputs. Alternatively, configuring can also be started by a double-click with the left mouse button.

Analog inputs → Maximize

This function prompts the display of the current configuration of the analog inputs. As an alternative, the current configuration can also be displayed by a click (left mouse button) on “Arrow to right” (▶).

Analog inputs → Online edit

The current settings of the analog inputs are read out directly from the instrument, and the change dialog is opened. Now you can alter the configuration. After alteration, the new setting is transmitted back to the instrument and entered in the dialog window.

If necessary, additional information that is required will be read out from the instrument and also entered in the dialog window. For instance, when editing the analog inputs online, the device data will also be read out from the instrument.

Copy data to clipboard → Analog inputs

This function copies the current configuration of the analog inputs to the Windows clipboard. The contents of the clipboard can, for instance, be imported into an editor or a text processing program.

Copy data to clipboard → All data

This function copies the complete current configuration – not just that for the analog inputs – to the Windows clipboard. The contents of the clipboard can, for instance, be imported into an editor or a text processing program.

Print

This function enables the print-out of the latest setting. You can select which parameter groups are printed out, and which are not. Alternatively, printing out can also be carried out via the *File* menu.

5 Setup program

5.5 Teleservice

You can use Teleservice to request the latest data from a paperless recorder. In addition, the Modbus flag can be switched (activated).

In order to use Teleservice, there must be an existing connection to a device.

⇒ Chapter 5.7 “Connection between the PC and the recorder”

You can switch Teleservice into or out of display via the *Window* menu.

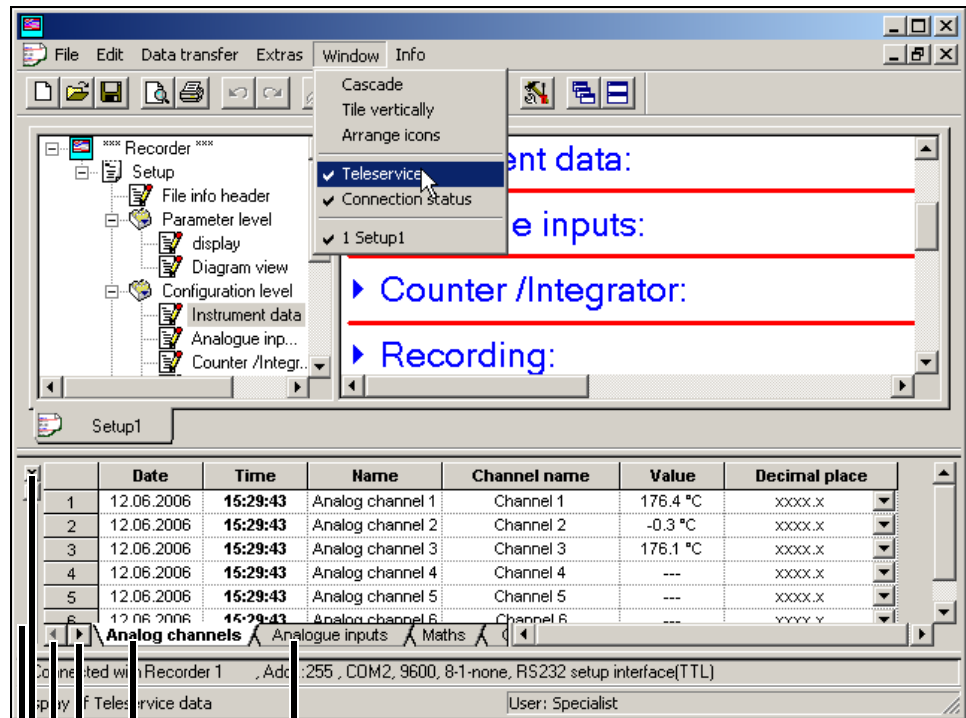

Click here to select the register as the active register

Active register

Click here to switch further registers into the display (if available)

Close Teleservice window

Shift the Teleservice window

⇒ “Shifting the toolbar” on page 80

5 Setup program

Setting the Modbus flag

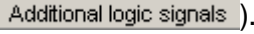
- * With the left mouse button, click on the arrow pointing to the right ( \ **Analog channels**), until the register “Additional binary signals” appears on the screen ().
- * Click on the register “Additional binary signals”. This automatically turns it into an active register.

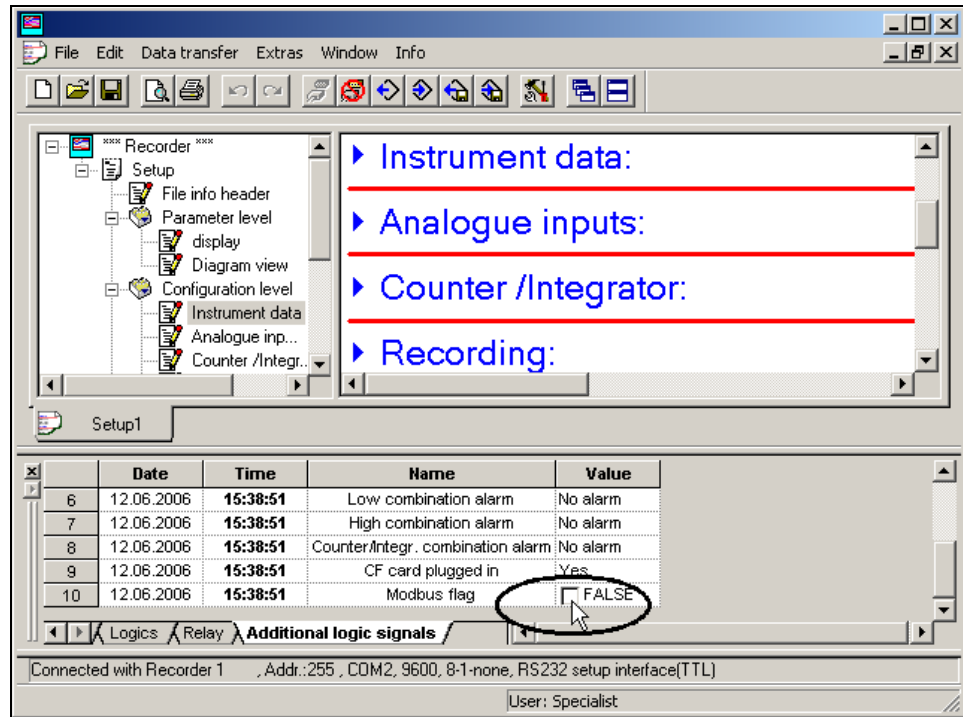

- * Clicking into the box with the left mouse button (single click) will switch the Modbus flag.

Shifting the Teleservice window

The Teleservice window, too, can be shifted. The same possibilities apply as for shifting the toolbar.

⇒ “Shifting the toolbar” on page 80

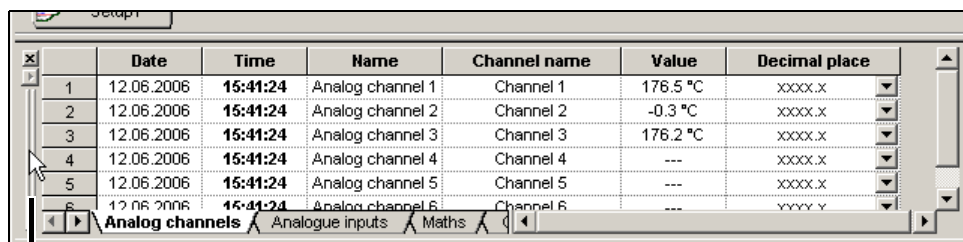

Position the mouse pointer here, and, holding the left mouse button down, shift the Teleservice window to a different position.

5 Setup program

5.6 Data transfer from and to the instrument

There are two ways of transferring the setup data to or from a recorder:

- transfer via the CompactFlash memory card and
- transfer via interface.



A new configuration will delete the data in the instrument (FLASH memory). If you want to retain the data, then the function *CompactFlash card* → *Update CF card* must be started, or the data must be read out with the PCA communications software (PCC) before the configuration is transmitted.

5.6.1 Transfer via CompactFlash memory card

In order to be able to read or write to CompactFlash memory cards from a PC, you will need a card reader/writer.

When you have installed the card reader/writer, and have inserted a CompactFlash memory card, you will automatically have a new drive under Windows. You can access the new drive just like a normal hard disk, using Windows Explorer.

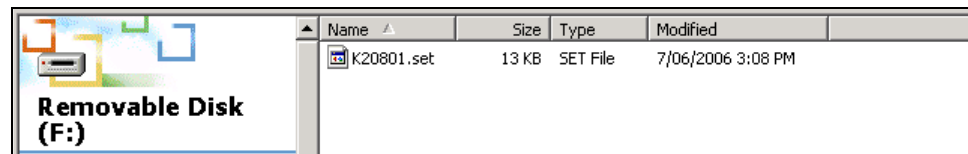

CompactFlash memory cards must only be removed from the card reader/writer if the function “Eject removable medium” (a function in the PC operating system) has been activated first.



Only one configuration file can be saved to the CF card at any time, since there is no file name as a variable.

Measurement data from several instruments can be on the same CF card, since they have unambiguous identifications.

5 Setup program

Paperless recorder

You can use the paperless recorder to write setup data to the CompactFlash memory card, or to read from it.

⇒ Chapter 3.6 “CompactFlash card”

Import/export errors

If an error occurs on the paperless recorder side during transfer from or to a CF card, it will be indicated in the CompactFlash card menu and will remain until the error has been eliminated or is overwritten by a fresh error message.

Setup program

Use the toolbar or the *Data transfer* menu with its functions “*Data export to CF card*” and “*Data import from CF card*” in order to transfer the setup data.



Data import from *CF card*

Data export to *CF card*



Do **not** use the menu function “File ‘ Save as ...”.

It cannot be used to create a valid CF card for the paperless recorder.

5 Setup program

Formatting the CF card



A CompactFlash memory card (CF card) must be formatted for FAT (**not** FAT32 or NTFS).

If you format a CF card yourself, you must **not** use fast-formatting (Quickformat). If this is disregarded, a fault-free exchange of data cannot be ensured.

To format a CF card using the Windows workplace (e. g. Windows XP):

- * Make a double-click on the workplace symbol in the “Desktop” area for the PC, using the left mouse button.
- * Click with the right mouse button on the drive letter for the CF card.
- * Select the function *Format*.

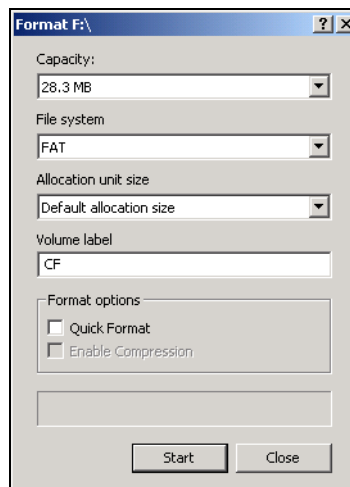

- * Select FAT file system.
- * Click on the “Start” button.

5.6.2 Transfer via interface

Data transfer is possible via one of the following interfaces:

Paperless recorder	PC
Setup interface	RS232
Setup interface	USB
RS232	RS232
RS485	RS485 (plug-in card or converter)
Ethernet	Ethernet

⇒ The settings for the interface parameters can be found in Chapter 4.2.10 “Configuration - Interfaces”.

Setup - RS232

You will need the interface cable (including adapter) in this case. It is available as an accessory for the recorder.

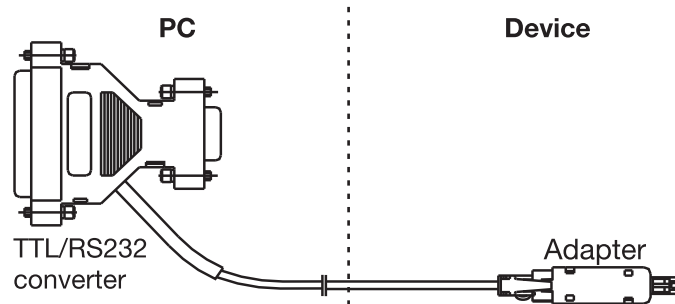

Setup - USB

You will need the interface cable (including adapter) in this case. It is available as an accessory for the recorder.



RS232

⇒ For the pin assignment, please refer to the Interface Description 59482.

RS485

⇒ For the pin assignment, please refer to the Interface Description 59482.

5 Setup program

Ethernet

The paperless recorder or a PC can be connected to the network using normal, commercially available network cables (with RJ45 connector). If the recorder and a PC are to be connected directly together, please use a crossover cable.



Only one PC (client) at a time can access the instrument (server) via the Ethernet interface.

Starting the transfer

Use the toolbar or the *Data transfer* menu with its functions “*Data export to device*” and “*Data transfer from device*” in order to transfer the setup data.



Data transfer from device

Data transfer to device

5.7 Connection between the PC and the recorder

If data are to be exchanged between a recorder and a PC, it is essential to define which instrument and which route is used for communication, and to establish a connection between the instrument and the PC.

Connection to an instrument is made by using the function *Data transfer* → *Establish connection* or by a click on the  symbol.



If a connection already exists (communication is active) between the setup program and a recorder, then no other software components (e.g. PCC) can access the instrument through the same interface.

5.7.1 Assistant for device settings

If there has never been any previous communication with an instrument, the “Assistant for Device Settings” will automatically be started when the first attempt is made to access the instrument. This helps you to set up a device list.

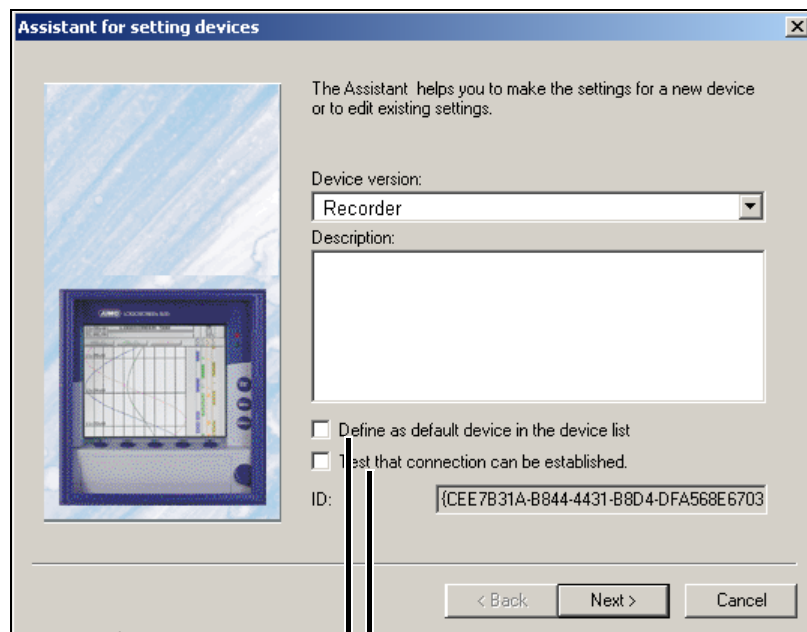

If the option is active () , a check is made at the end whether the chosen device can be accessed via the selected interface.

Here you can choose whether the device should be defined as the default device (). The system will automatically access a default device, other devices must be linked through the device list.

5 Setup program

- * First select the device version.
- * Enter an additional description, if appropriate.
- * Set one of the option fields, if appropriate.
- * Activate the  button.

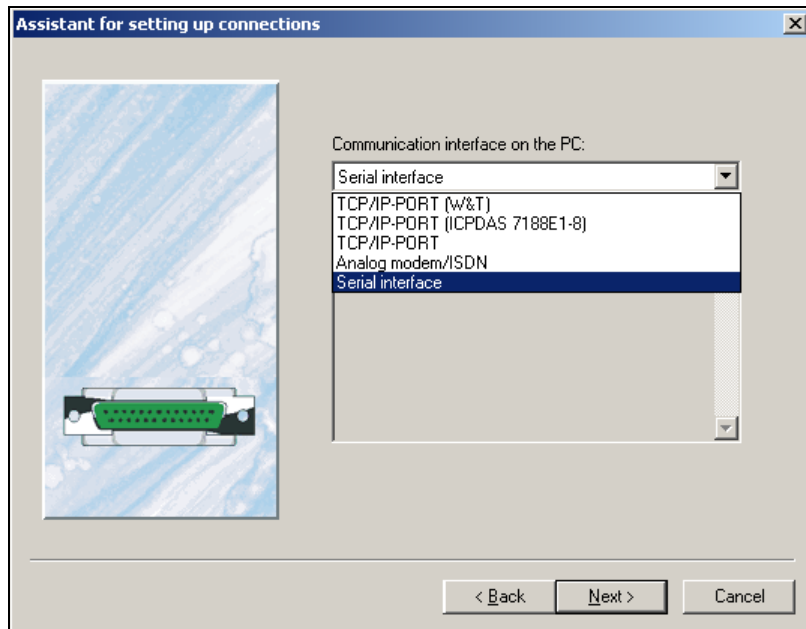

- * Select the interface which you want to use to access the device.
- The next steps depend on the interface or type of connection that has been selected.

5 Setup program

TCP/IP PORT

The following parameters must be selected:

IP address / HOST name	xxx.xxx.xxx.xxx (Example: 192.168.0.10)	Enter the IP address of your device. If you enter the name, the IP address can be determined by clicking on the button "Convert HOST name to IP address".
Port number, port name	502	The port used for communication.
Communications protocol	Modbus TCP/IP, Modbus protocol	Set the Modbus TCP/IP here.
Communications password	0	The communications password must match the one that has been set in the device.

Analog modem / ISDN

The following parameters must be selected:

Telephone number		Enter the telephone number for connecting to the required device.
Connect via		Select the modem that is to be used to make the connection.
Communications protocol	Modbus TCP/IP, Modbus protocol	Set the Modbus protocol here.
Device address	1 – 255 (255 can only be set if just one device is connected)	Device address for the Modbus protocol.
Communications password	0	The communications password must match the one that has been set in the device.

Serial interface

The following parameters must be selected:

Connected to	COM1, COM2	The PC interface to which the paperless recorder is connected.
--------------	------------	--

5 Setup program

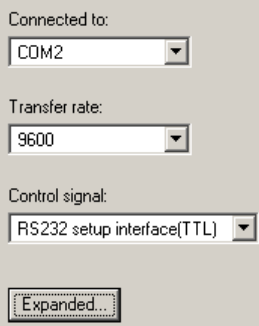
Transmission rate	9600, 19200, 38400	The transmission rate must match the one set in the device. If “RS232 setup interface (TTL)” has been selected as the control signal, then 9600 must be set.
Control signal	RS232	If the RS232 interface on the device is used.
	RS232 setup interface (TTL)	If the setup interface on the device is used.
	RS422-RTS	If the RS422/485 interface on the device is used.
	RS422-DTR	
	RS485-RTS	
RS485-DTR		
Expanded 	Stop bit and parity	The parameters under the “Expanded” button must also match those in the device. Standard and obligatory setting for the control signal “RS232 setup interface (TTL)”: Stop bit = 1 Parity = none
Communications protocol	Modbus TCP/IP, Modbus protocol	Set the Modbus protocol here.
Device address	1 – 255 (255 can only be set if just one device is connected to the interface)	Device address for the Modbus protocol. If the “RS232 setup interface” is used as the control signal, then the device address will be ignored – it does not have to match the address in the device.
Communications password	0	The communications password must match that set in the device. Exception: Communication via the setup interface can always be established without a communications password.

5 Setup program

Device list When all settings have been made, the device is entered in the device list.

5.7.2 Device list

All devices that have been defined are shown in a device list. The interface parameters are also administered here, and new, additional devices can also be defined in the device list.

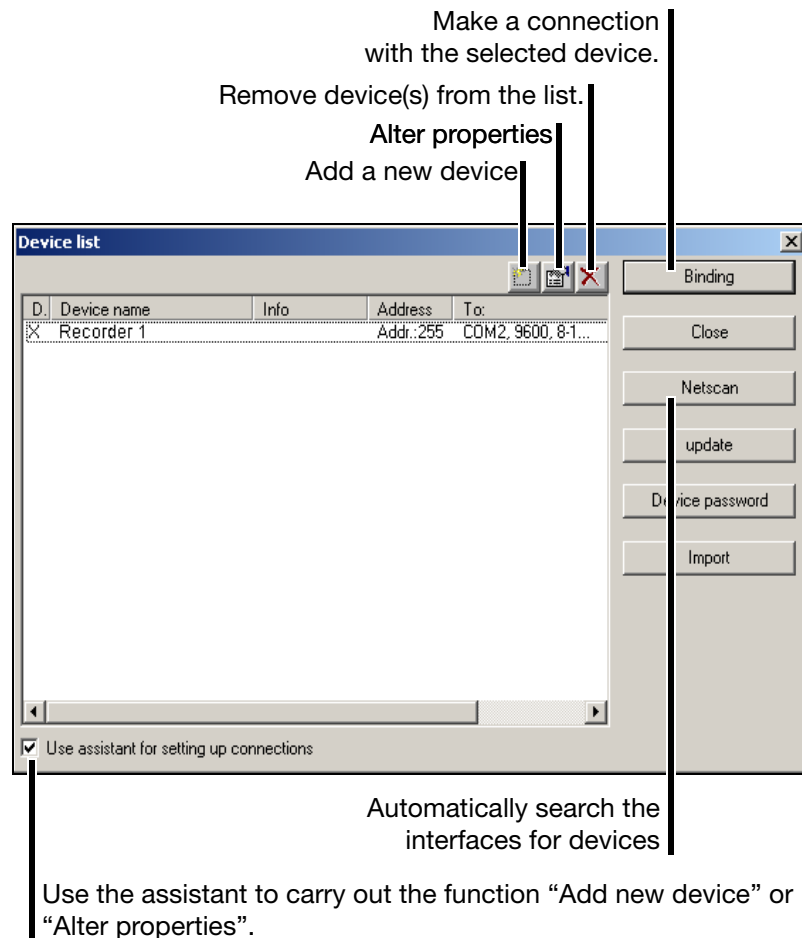

Use the **Binding** button to make a connection to a device. By using the Ctrl key on the PC keyboard and the left mouse button, you can select several devices at the same time (only for deleting devices from the device list).

A successful connection produces a change in the toolbar.

Not connected



Connected



5 Setup program

5.8 Menu functions

5.8.1 File

New	Opens a new setup in the working area. The values will be preset to the factory default settings.
Open	Opens an existing setup from a file, and present the contents in the working area.
Save	Saves the setup that is shown in the working area to a file. It is only necessary to enter the file name once. If the file is saved again, no query is made about the file name.
Save as	Saves the setup that is shown in the working area to a file. Unlike the <i>Save</i> function, this always asks for a file name.
Close	Removes a complete setup from the working area. If changes have not yet been saved, this can still be done immediately after calling up the <i>Close</i> function.
Delete	Deletes a file from a hard disk or another data storage medium.



Deleted files cannot be recovered.

Export as RTF text	The current setup can be saved as an RTF file on the PC.
Print	When you have called up the function, the selection of what is to be printed appears first. Printing will start when the selection has been concluded.
Print preview	The printed result is displayed on the screen. You can let several pages be displayed, and alter the size of the pages on the screen.
Printer setup	Here you can make alterations to the settings for your printer. When the program is started, the Windows default printer will always be set as the active printer.
Default settings	Here you can make alterations to the default settings for the program. Many alterations will only take effect after a fresh start of the setup program.
Exit	This closes the setup program.

5.8.2 Edit

Undo ... Undoes the last editing action. In the menu, the item *Undo* shows which setting will be undone.

Restore ... The *Restore* function will only be available when the *Undo* function has been activated. This function repeats the setting that was previously canceled by the *Undo* function.

Parameterization This function has the same effect as a double-click with the left mouse button on the following function in the dialog window.

▶ Display:

▶ Diagram view:

Configuration level This function has the same effect as a double-click with the left mouse button on one of the following functions in the dialog window.

▶ Instrument data:

▶ Analogue inputs:

▶ Counter /Integrator:

▶ Recording:

▶ Outputs:

▶ Operating functions:

▶ Texts:

▶ Interface:

▶ Undocumented parameters:

Settings through setup only This function has the same effect as a double-click with the left mouse button on the following function in the dialog window.

▶ Maths / Logics:

⇒ Chapter 5.9 “Math/logic”

5 Setup program

Setup data info This function has the same effect as a double-click with the left mouse button on one of the following functions in the dialog window.

▶ **File info header:**



▶ **File info text:**



5.8.3 Data transfer

Make connection This function establishes a connection to a device. A connection to a device is a precondition for transferring a setup to or from a device via an interface (serial or Ethernet).

Disconnect This breaks an existing connection. A connection to a device must be broken before a new connection can be established to another devices.

Data transfer to device Transmits a setup to a device.

Data transfer from device Read in a setup from a device. If there is no connection, the program will automatically attempt to access the default device.

Data export to CF card The setup will be saved on a CompactFlash card. The CompactFlash card can be read by the device.

Data import from CF card This reads a setup from a CompactFlash card, and displays it in the working area.

5.8.4 Extras



All the functions in the *Extras* menu which require access to a device must have a connection to the device.



If there is no connection, the setup program will try to access the default device from the device list. If no default device has been defined, then the device list will appear on the screen and the user must set up a connection by hand.

Enable program options If no valid serial number was entered during the installation of a program, then it will only run in a 30-day test or demo mode. This function can be used to register a program at a later date, to convert it into a full version.

5 Setup program

Enable extra codes

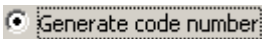
This function is intended for later extensions within the paperless recorder (e. g. enabling the extra code for “Integrators, counters, math and logic module”).

After starting up the function, the  function must be used to read out a code number from the device, and then passed on to the manufacturer. The manufacturer will then generate a “release number”. The  function is used to transmit this release number to the device, which will then enable the new device functions.

Calibration/ Test

This carries out a calibration and various test functions. Calibration can only be carried out with a special license number, and is reserved for the manufacturer’s service personnel.

After activating *Extras* → *Calibration/Test* and confirming the security instruction, a device must be selected, if one is not already connected. The dialog window will then appear, the hardware and software are automatically read out, and information about the result will be displayed.

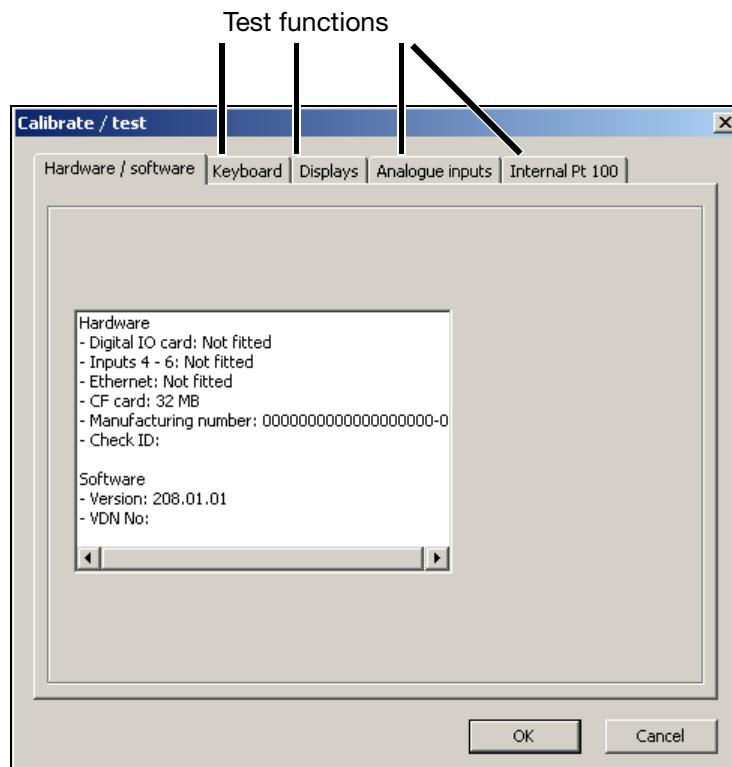

Some test functions cannot be terminated as long as there is a connection to the instrument. If necessary, use the dialog window to close down the connection.

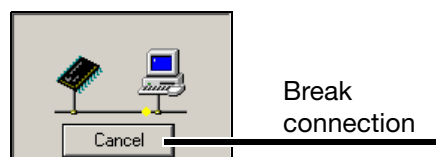

5 Setup program

Date and time This function is used to match the date and time for a PC and a device.

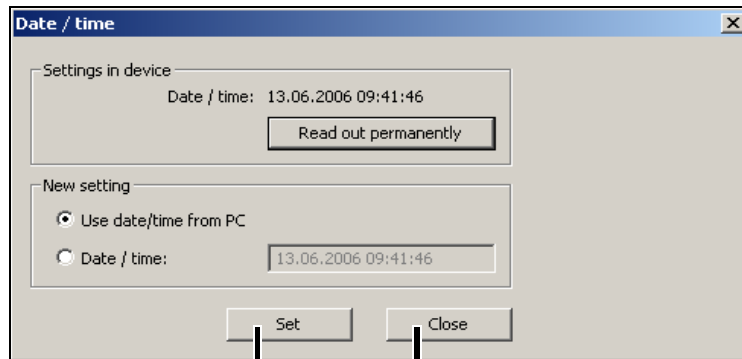

Terminates the function.
Send the date and time to a device.

The **Set** button is used to make date and time settings for a device. This function uses the information in the “New setting” selection as the basis for adjustment.

Read out permanently ensures that the device clock is read out continually (cyclically). The continual read-out can be ended by activating **Cancel**. The clock cannot be adjusted while it is being continually read out.

Create screen printout This function provides you with another option for documenting settings or events. Start the function and operate the “Create” button. A screenshot (printout) will be created for the device that is connected. You can save the screenshot as a bitmap, or print it out directly.

Start picture With this function, the start screen (start logo after power-on) can be read, altered or swapped, and transmitted to the recorder.

Write message text This function can be used to transmit a message text to a device. The message text can be used to make an entry in the event list for a device. The functions are independent of the present setting in the dialog window. The data can be transmitted to a device, without causing a new configuration.

Ethernet interface Using this function, the Ethernet parameters “IP address”, “Subnet mask” and “Gateway” can be transmitted to the recorder. They are transmitted to that device which has been linked to the setup program via the device list. When transferring setup data through “data transfer to device“, “data transfer from device“, “data export to CF card“ or “data import from CF card“, the Ethernet parameters are not transmitted with this data, to avoid a collision of data in the network due to identical IP addresses.

5 Setup program

Renew log-in / Alter password

The function *Renew log-in / Alter password* is used to

- activate the user and password query at the program start and
- alter the current password.

This function only has an affect on the operation of the setup program, not the recorder.

Activation of the user and password query at the program start

When the setup program is installed for the first time, there will not yet be a query of the user name and password when the program starts. You will automatically be logged in as “Specialist”, with a blank password.

Proceed as follows:

- * Start the function “Renew log-in / Alter password”.
- * Show the options.

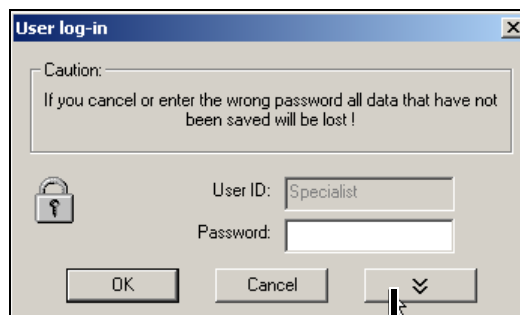

Show the options.

- * Activate the option “After log-in – alter password” and click on the  button.

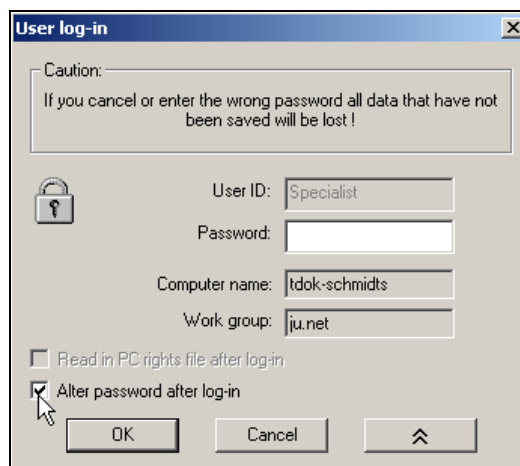

5 Setup program

- * Enter the password - the “Old password” field remains empty.



The screenshot shows a 'Change password' dialog box. It has a title bar with the text 'Change password' and a close button. On the left side, there is a lock icon. The main area contains the following fields and labels: 'User ID:' followed by a text box containing 'Specialist'; 'Old password:' followed by an empty text box; 'New password:' followed by a text box containing 'xxxxx'; and 'Confirm new password:' followed by a text box containing 'xxxxx'. At the bottom, there are two buttons: 'OK' and 'Cancel'. A mouse cursor is pointing at the 'OK' button.

When the entry has been concluded, the new password is activated by clicking . From now on, the user name and the password will be requested at the program start.



Initially, no start password is assigned to the “Maintenance” user either. At program start, log in with the “Maintenance” user name and enter a password as described above.

Password alteration

Altering a password is very much like activating the password query. The only difference is that, in this case, the “Old password” field must not remain empty.

5.8.5 Window



The usual Windows options are available for the positioning of the dialog windows.

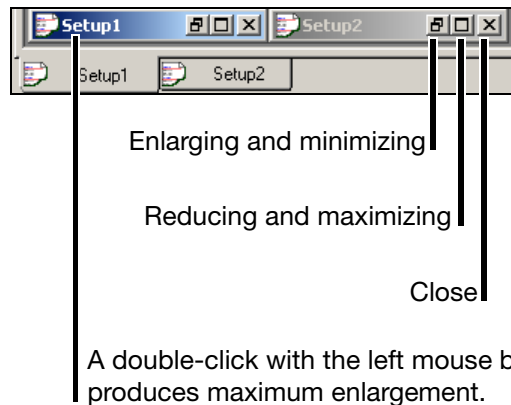

Cascade

If several dialog windows are open at the same time, this function has the effect that all windows are shown with an offset to one another. You can use the left mouse button to bring a window into the foreground.

Tiled horizontally

If several dialog windows are open at the same time, this function has the effect that the various windows are shown one above another. You can use the left mouse button in a window to make that window active.

Arrange symbols

All open windows are minimized – they disappear from the screen, but are not closed.

Teleservice

You can switch Teleservice into or out of display by using this function. The position is independent of the position of the dialog window.

⇒ Chapter 5.5 “Teleservice”

Connection status

You can switch the connection status into or out of display by using this function. The position is independent of the position of the dialog window.

⇒ See “Connection status” on page 80.

5 Setup program

5.8.6 Info

Info on setup	Here you can find out the version number of the setup program. Please have the version number available if you contact the service hotline.
Software documentation	This function calls up the available instrument and software documentation in PDF format.
Registered license numbers	Here you can find out the license number of the setup program. Please have the license number available if you contact the service hotline.
Program folder	Here you can obtain information as to which folders (directories) on the hard disk or in the network are used by the setup program. If you activate the  button, the contents of the folder will be displayed.

5.9 Math/logic

The math and logic module is available as an extra code. It has to be ordered from the start, or subsequently enabled through the function *Extras* → *Enable extra codes* (Page 98).

The math/logic module is composed of channels that are not available as hardware but are calculated by the instrument software.

Math

You can activate the math channels in the setup program, in the “Math / logic” area, or through the menu *Edit* → *Settings through setup only* → *Math / logic*.

▶ Maths / Logics:

In the following example, math channel 3 will be configured:

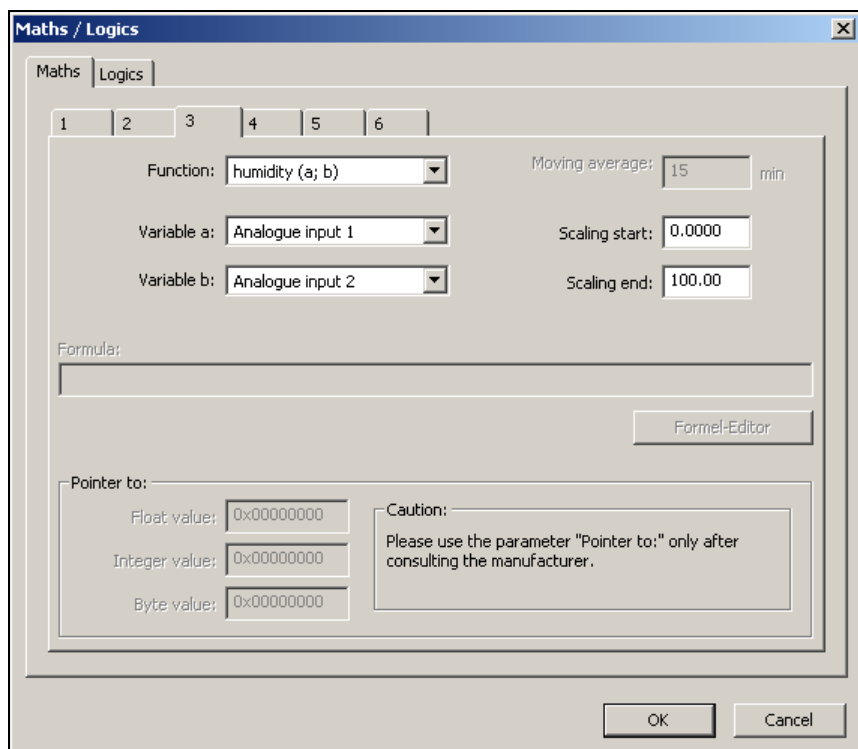

5 Setup program

Function selection

The function is selected here. All other fields can subsequently be edited according to the function.

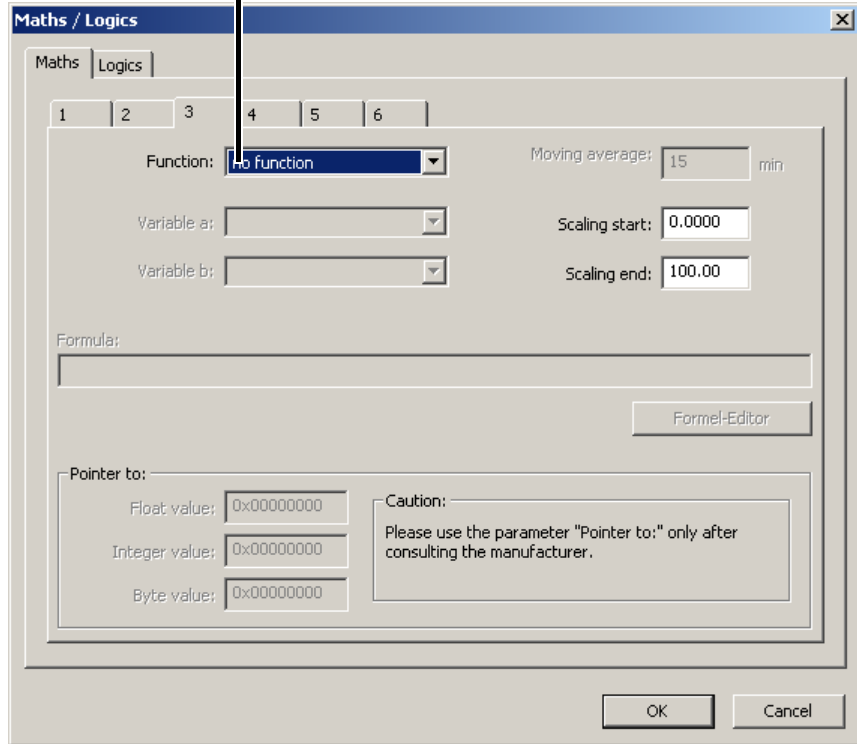

You must edit the input fields “Variable a”, “Variable b” or “Time for moving average” if one of the standard functions (difference, ratio, humidity, moving average) has been set.

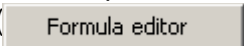
If you have set the “Formula” function, then the input field “Formula” must be edited. Entry can either be direct or via a () dialog.

Example: humidity

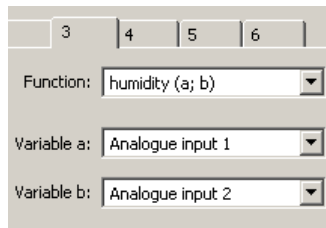



With humidity measurement, the channel for dry bulb temperature has to be specified as variable a, the channel for the wet bulb temperature as variable b.

Example: Formula

The formula can be entered directly from the PC keys or by calling up the  function.

 Formula editor

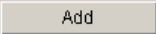
When you have called up the function, this dialog box will appear:

In the left window you can select the required signal, in the right window the required operator, and enter them into the formula by activating the corresponding button (). Instead of using , you can also make a selection by a double-click with the left mouse button.



For functions ending with (), you will have to add the closing bracket yourself.

Example: 1. add in SQRT() --> **SQRT(**
 2. add in AE1 --> **SQRT(AE1**
 3. add in) --> **SQRT(AE1)**



The functions “Pointer to float values”, “Pointer to integer values” and “Pointer to byte values” may only be used on express instruction from the manufacturer.

5 Setup program

Operator overview

Operator	Explanation	Example
+	addition	AE1 + AE2
-	subtraction	AE1 - AE2
*	multiplication	AE1 * AE2
/	division	AE1 / AE2
(opening bracket	(
)	closing bracket)
SQRT()	root	SQRT (AE1)
MIN()	minimum value	MIN (AE1, AE2)
MAX()	maximum value	MAX (AE1, AE2, AE3)
SIN()	sine	SIN (AE1)
COS()	cosine	COS (AE1)
TAN()	tangent	TAN (AE1)
**	x to the power y	AE1 ** AE2
EXP()	exponential function	EXP (AE1)
ABS()	absolute value	ABS (AE1)
INT()	integer portion	INT (AE1)
FRC()	decimal portion	FRC (AE1)
LOG()	logarithm	LOG (AE1)
LN()	natural logarithm	LN (AE1)

Operator priorities

Math calculation signs and functions

Priority	Math sign / function	Comment
high	()	brackets
	SQRT, MIN, MAX, LOG, LN, SIN, COS, TAN, ABS, EXP, INT, FRC	functions
	**	exponent (x^y)
	+, -	sign
	*, /	multiplication, division
low	+, -	addition, subtraction

Logic operators

Priority	Operator	Comment
high	()	brackets
	NOT, !	negation
	AND, &	AND linkage
	XOR, ^	exclusive OR linkage
low	OR, ;	OR linkage

5.10 Character set

032		080	P	0161	ı	0209	Ñ
033	!	081	Q	0162	ç	0210	Ò
034	"	082	R	0163	£	0211	Ó
035	#	083	S	0164	¤	0212	Ô
036	\$	084	T	0165	¥	0213	Õ
037	%	085	U	0166	ı	0214	Ö
038	&	086	V	0167	§	0215	×
039	'	087	W	0168	¨	0216	Ø
040	(088	X	0169	©	0217	Ù
041)	089	Y	0170	ª	0218	Ú
042	*	090	Z	0171	«	0219	Û
043	+	091	[0172	¬	0220	Ü
044	,	092	\	0173	-	0221	Ý
045	-	093]	0174	®	0222	Þ
046	.	094	^	0175	¯	0223	ß
047	/	095	_	0176	°	0224	à
048	0	096	‘	0177	±	0225	á
049	1	097	a	0178	²	0226	â
050	2	098	b	0179	³	0227	ã
051	3	099	c	0180	´	0228	ä
052	4	0100	d	0181	µ	0229	å
053	5	0101	e	0182	¶	0230	æ
054	6	0102	f	0183	·	0231	ç
055	7	0103	g	0184	¸	0232	è
056	8	0104	h	0185	¹	0233	é
057	9	0105	i	0186	º	0234	ê
058	:	0106	j	0187	»	0235	ë
059	;	0107	k	0188	¼	0236	ì
060	<	0108	l	0189	½	0237	í
061	=	0109	m	0190	¾	0238	î
062	>	0110	n	0191	¿	0239	ï
063	?	0111	o	0192	À	0240	ð
064	@	0112	p	0193	Á	0241	ñ
065	A	0113	q	0194	Â	0242	ò
066	B	0114	r	0195	Ã	0243	ó
067	C	0115	s	0196	Ä	0244	ô
068	D	0116	t	0197	Å	0245	õ
069	E	0117	u	0198	Æ	0246	ö
070	F	0118	v	0199	Ç	0247	÷
071	G	0119	w	0200	È	0248	ø
072	H	0120	x	0201	É	0249	ù
073	I	0121	y	0202	Ê	0250	ú
074	J	0122	z	0203	Ë	0251	û
075	K	0123	{	0204	Ì	0252	ü
076	L	0124		0205	Í	0253	ý
077	M	0125	}	0206	Î	0254	þ
078	N	0126	~	0207	Ï	0255	ÿ
079	O	0128	€	0208	Ð		

5 Setup program

Entering special characters

Any (special) characters that cannot be entered directly from the keyboard of the PC can be entered with the help of the A key and the numerical combinations that are specified in the table.

Example

The special character © has to be entered:

- * Position the cursor with the mouse, or by using the cursor keys, on the point where the character is to be inserted.
- * Press the A key **and hold it down**
- * Enter the number combination 0169 in the number block (on the right-hand side of the keypad) (the leading zero **must** be entered as well)
- * Release the A key

The character © is inserted at the cursor position.

Cyrillic characters



The character set depends on the language of the operating system that is used, and may be different from the example.

If “Russian” has been selected as the language for the instrument, then the characters 0192 ... 0255 will be replaced by Cyrillic letters in the instrument.

6.1 Rights with regard to the setup program

Depending on the installation and the log-in, individual users will have different rights within the setup program.

The differences are summarized in the table below:

Right	Demo installation	Maintenance	Specialist
Write interface texts	-	X	X
New	X	X	X
Open	X	X	X
Save, Save as, Delete	-	X	X
Configure undocumented parameters	-	-	X
Export to CF card	-	X	X
Import from CF card	-	X	X
Print	-	X	X
Enable program options	X	-	X
Enable extra codes	-	-	X
Edit interface settings	-	X	X
Edit device settings	X	X	X
Delete device	-	-	X
Create new device	X	-	X
X = right is available			

6 Rights

7.1 PC evaluation software (PCA3000)



Operating Instructions 59498 describe PCA300 in detail.

PCA3000 is the professional evaluation software for data-analysis of the archived instrument process data.

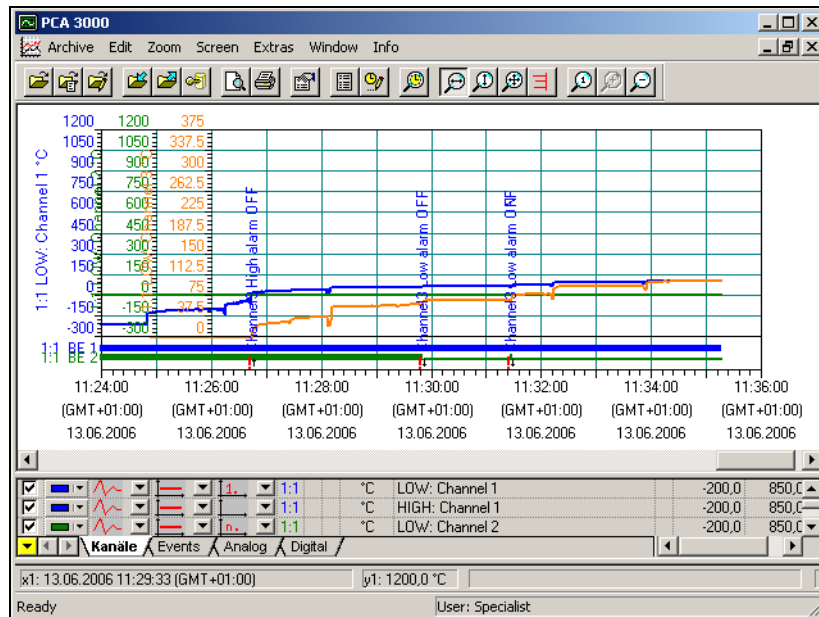

PCA3000 is the ideal software for the best-quality graphic and alphanumeric display of electronically stored measurement data. The software supports multi-user functionality, so that different users can access the same data. PCA3000 runs under Windows NT, Windows 2000 and Windows XP.

- Data storage** The life-cycle archive data structure enables on-demand saving and archiving of all process data, clearly and simply, in a single file.
- Data backup** Archive data can be read out and visualized directly from a CD-ROM or DVD (a transfer to the hard disk is not necessary).
- Data export** Data export at the HTML level, or as an ASCII text file (for evaluation in Excel).
- Communication** The data transfer program PCC (communications software) is perfectly matched to PCA3000, and enables the comfortable read-out of data through the interface, using RS232/ RS422, Ethernet, a modem, or through the setup interface.

7 PC programs

7.2 PCA communication software (PCC)



PCC is described in detail in the Operating Instructions 59500.

PCC is the professional archive software: it transfers the data via an interface (setup, serial or Ethernet) from the recorder (or several recorders and controllers), and deposits them on a PC or a network.

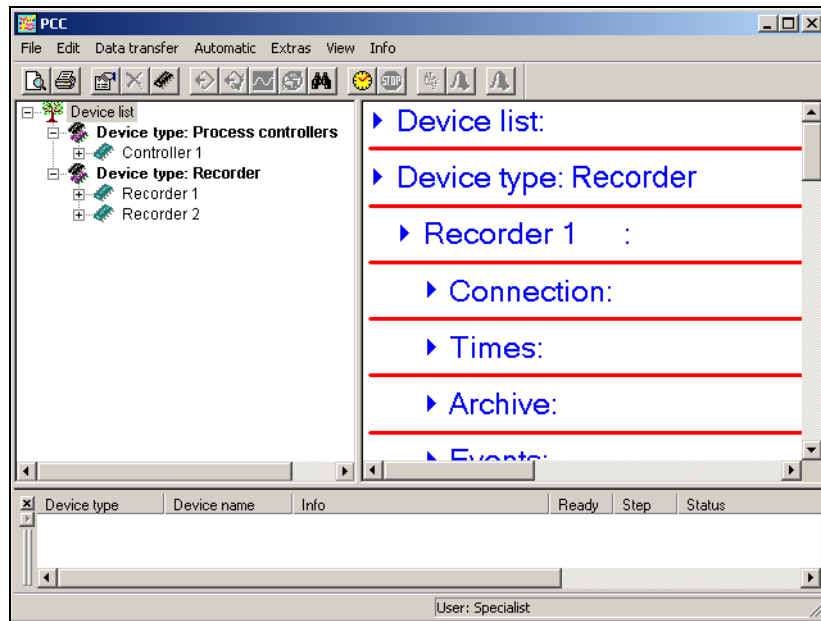

8 Identifying the instrument version

8.1 Type designation

INPUT SLOT 1

3 Universal Inputs

6 Universal Inputs

Power supply options

110 - 240 V AC, 48-63 Hz

20 - 53 V AC/DC, 48-63 Hz

Option 1

Lithium battery for memory buffering

Lithium battery for memory buffering + Ethernet interface

Capacitor for memory buffering

Capacitor for memory buffering + Ethernet interface

Option 2

none

Mathfunction module

4 DI / 3 Relay outputs, RS232/485

Mathfunction module + 4 DI / 3 Relay outputs,
RS232/485

Option 3

none

w

Universal carrying case

IP65 deal with wide mounting brackets +

Universal carrying case

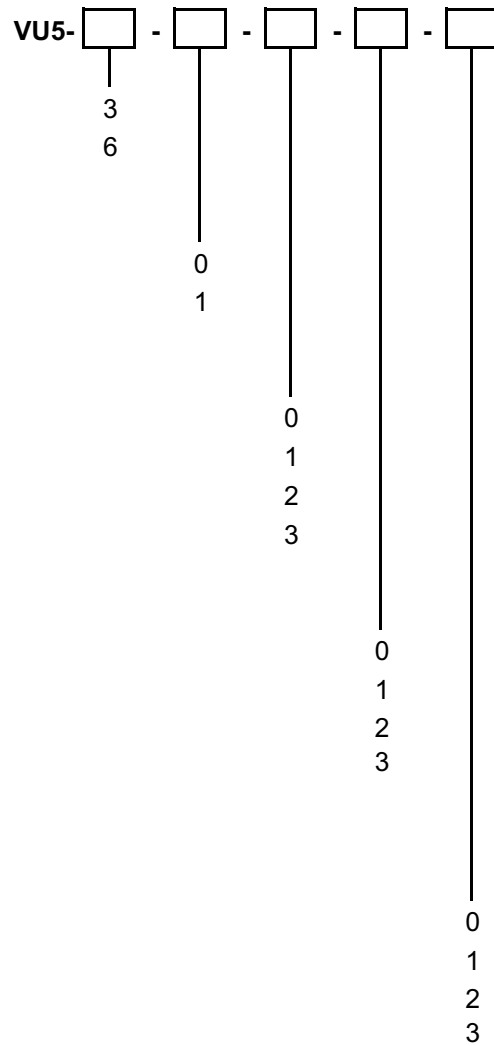

8 Identifying the instrument version

8.2 Standard accessories

- 1 Operating Instructions 59480
- 2 mounting brackets, or 4 mounting brackets with IP65
- 1 control panel seal with IP65
- 2 cover plates for fixing holes
- Cable tie with foot (can be released)
for strain relief of the sensor connecting cables

8.3 Optional accessories

- Setup program, multilingual
- PC interface with USB/TTL converter, adapter (socket) and adapter (plug)
- PC evaluation software (PCA3000), multilingual
- PCA communications software (PCC), multilingual
- Inputs configured to customer specification
- Universal carrying case

9.1 Installation site and climatic conditions

The installation site should be free from vibration. Electromagnetic fields, caused by motors, transformers etc. should be avoided.

The ambient temperature at the site should be 0 to +45°C, with a relative humidity of $\leq 75\%$, no condensation.

⇒ Chapter 10.1 “Installation notes”

9.2 Fitting

Views

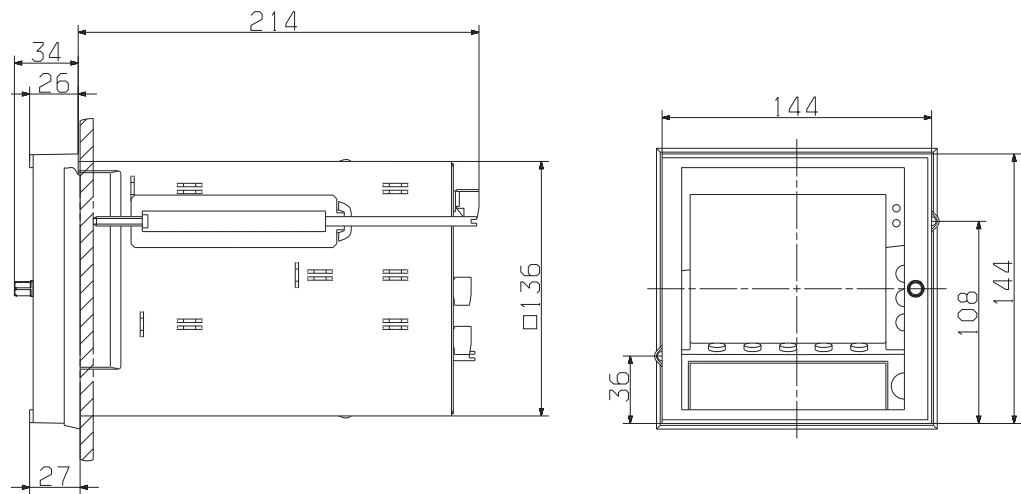

Size 26 increases to 27 if the IP65 seal is used.

Panel mounting

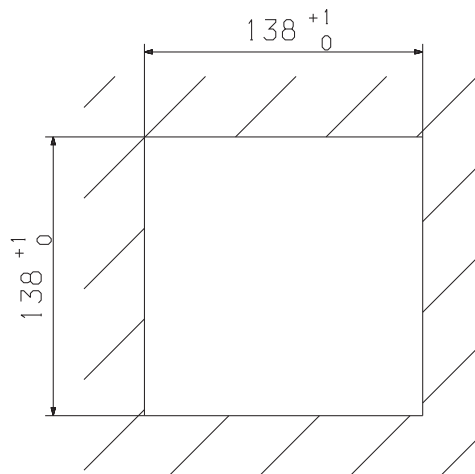

9 Installation

Installation

- * Insert the paperless recorder from the front into the panel cut-out.
- * From behind the panel, hook the two mounting brackets into the grooves on the sides of the housing. The flat faces of the mounting brackets must lie against the housing.

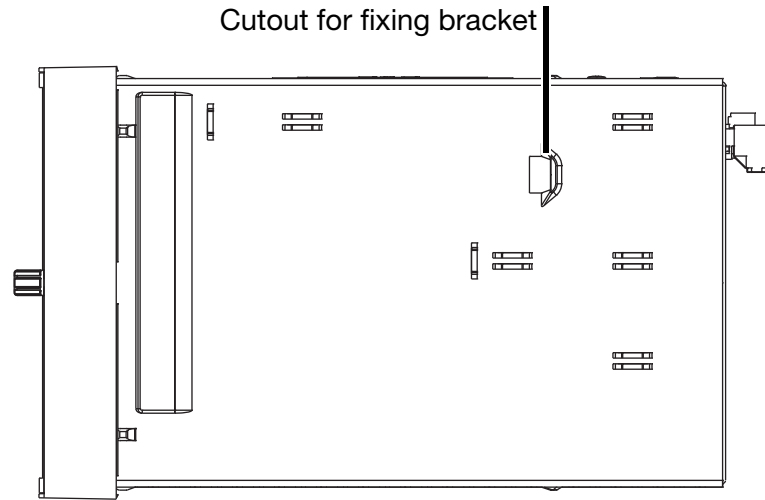

- * Push the fixing brackets up against the back of the panel and tighten them evenly.

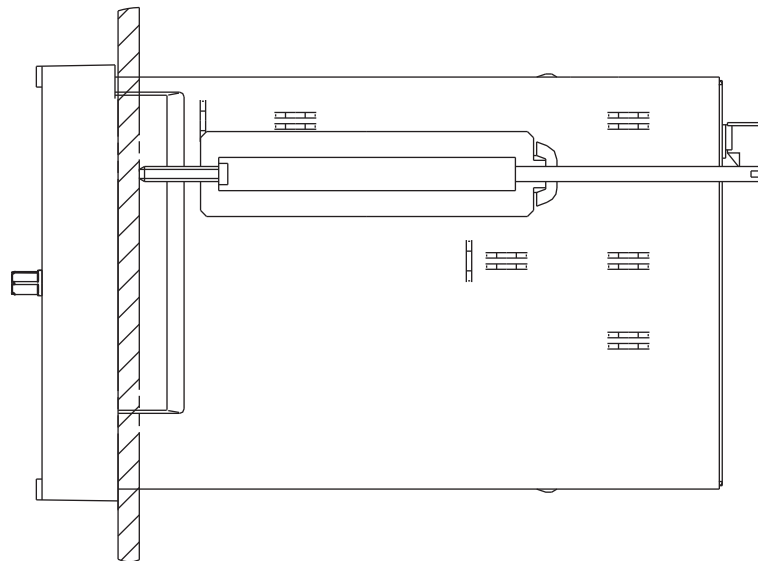

- * Use the cover plates to close the remaining cutouts for mounting brackets.

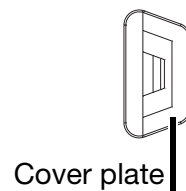

9 Installation

Extra code IP65 The following instructions must be followed when installing the paperless recorder with extra code IP65.

- The seal for the control panel must be fitted before the recorder is installed.

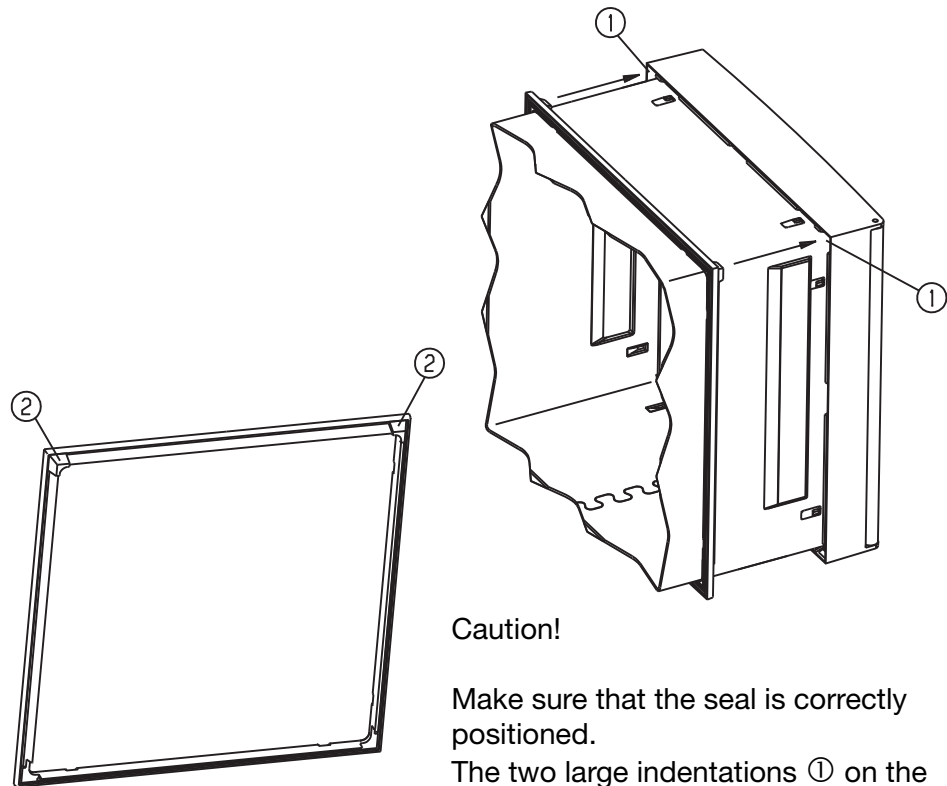

Caution!

Make sure that the seal is correctly positioned.

The two large indentations ① on the front frame must be closed by the two lugs on the seal.

- Instead of the 2 mounting brackets, there are 4 wide mounting brackets that have to be used (one element for each side of the housing).
- The cover plates for closing the cutouts for the mounting brackets must not be used.

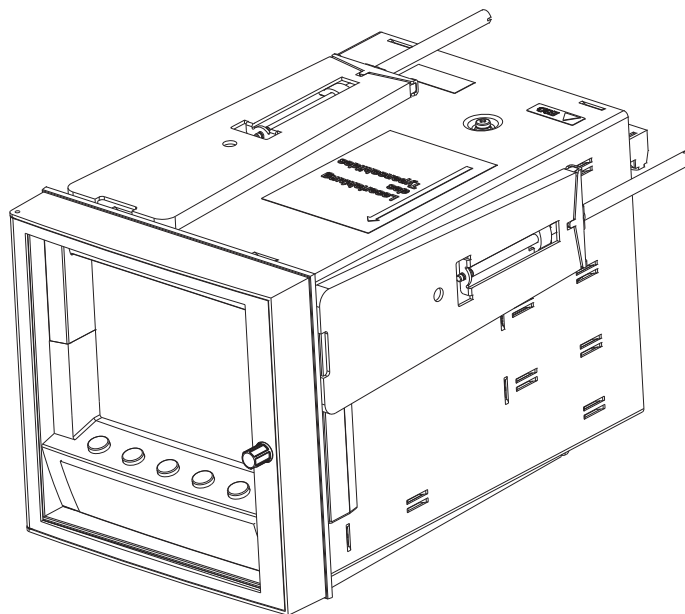

9 Installation

10.1 Installation notes

- The choice of cable, the installation and the electrical connection must conform to the requirements of VDE 0100 “Regulations on the Installation of Power Circuits with Nominal Voltages below 1000V” or the appropriate local regulations.
- Work inside the instrument must only be carried out to the extent described and, like the electrical connection, only by qualified personnel.
- The instrument must be disconnected on both poles from the electrical supply if contact with live parts is possible while work is carried out.
- Electromagnetic compatibility (EMC) conforms to the standards and regulations cited in the technical data.
⇒ Data Sheet DS-DV5-1-EN-1202
- Run input, output and supply cables separately and not parallel to one another.
- All input and output cables without connection to the mains supply must be arranged as twisted and screened cables. Earth the screen on the instrument side to the earth potential.
- Earth the instrument at the PE terminal to the protective earth conductor. This cable must have the same cross-section as that used for the supply cables. Earthing cables must be wired in a star configuration to a common earth point that is connected to the protective earth conductor of the electrical supply. Do not loop earthing cables, i.e. do not run them from one instrument to another.
- Do not connect any additional loads to the supply terminals of the instrument.
- The device is not suitable for use in areas with an explosion hazard (**Ex** areas).
- Inductive loads close to the instrument, such as contactors or solenoid valves, should have RC modules fitted for interference suppression.
- The instrument must be provided with external fusing and disconnection. Depending on the supply voltage, the following fuse values apply for the external fusing:

20 — 53V AC/DC, 48 — 63Hz	5A fuse, slow-blow
110 — 240V AC +10/-15%, 48 — 63Hz	5A fuse, slow-blow

10.2 Technical data

⇒ Data Sheet DS-DV5-1-EN-1202

10 Electrical connection

10.3 Connection diagram



The electrical connection must only be carried out by qualified personnel.

Rear view

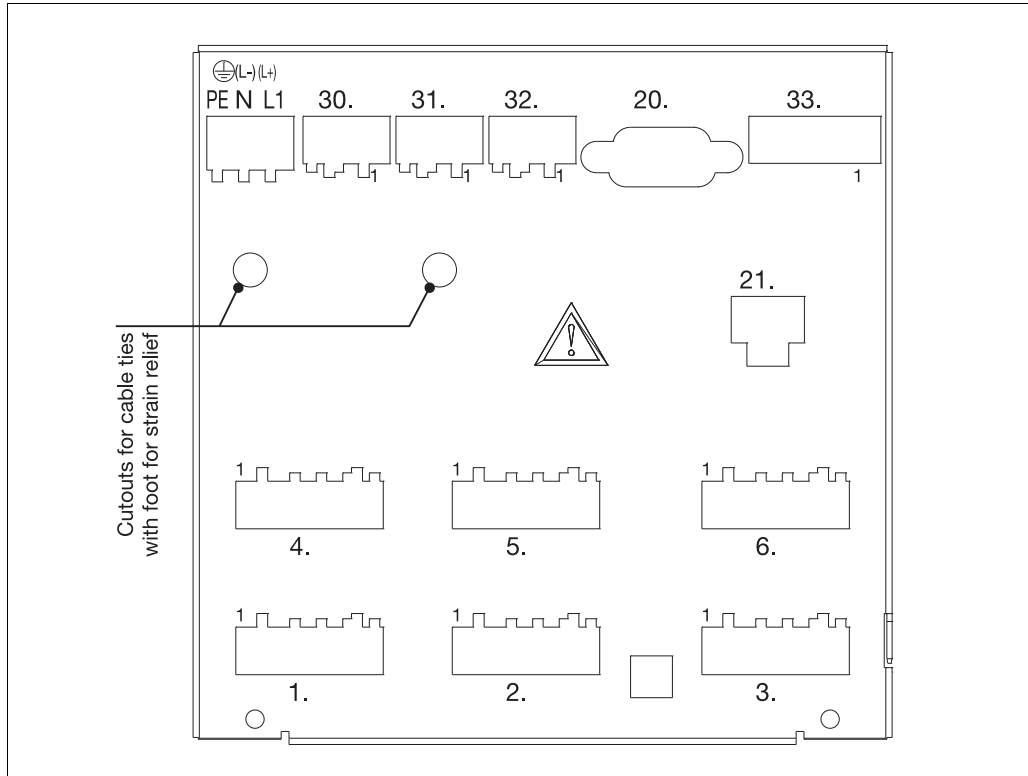

Terminal assignment (for pluggable screw terminals) 3/6 channel paperless recorder		Diagram
Supply voltage		
Supply voltage	PE ⊕ N (L-) L1 (L+)	<pre> PE N L1 o o o PE N L1 </pre>

10 Electrical connection

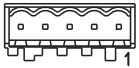
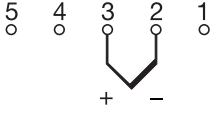
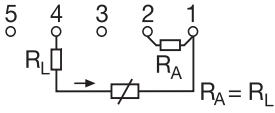
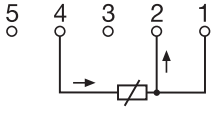
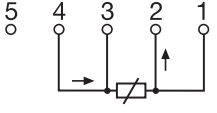
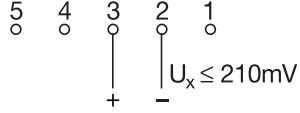
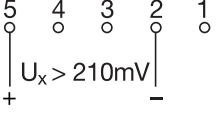
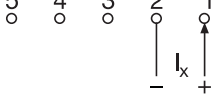
Terminal assignment (for pluggable screw terminals) 3/6 channel paperless recorder		Diagram
Analog inputs	Connector	
Thermocouple	1 to 6	
<p>If sizeable supply interference is present on a thermocouple input, then the corresponding analog input requires a link from terminal 2 to terminal 4. Increased interference voltages can, for example, be generated by ceramic insulation becoming conductive at temperatures of several hundred °C.</p>		
Resistance thermometers in 2-wire circuit	1 to 6	
Resistance thermometers in 3-wire circuit	1 to 6	
Resistance thermometers in 4-wire circuit	1 to 6	
Voltage input $\leq 210\text{mV}$	1 to 6	
Voltage input $> 210\text{mV}$	1 to 6	
Current input	1 to 6	

10 Electrical connection

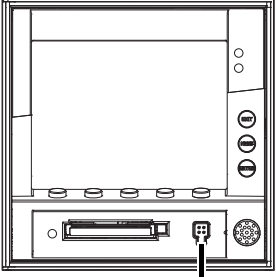
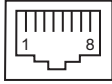
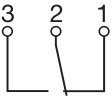
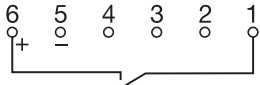
Terminal assignment		Diagram
Setup interface (included in delivery)		
The setup interface can be found on the front of the instrument, behind the cover for the CompactFlash memory card.		 <p>Setup interface</p>
Interfaces (extra code)		
RS232 9-pole SUB-D socket	20	2 RxD receive data 3 TxD transmit data 5 GND ground
RS485 9-pole SUB-D socket	20	3 TxD+/RxD+ transmit/receive data + 5 GND ground 8 TxD-/RxD- transmit/receive data -
Ethernet RJ45 socket	21	 1 TX+ transmit data + 2 TX- transmit data - 3 RX+ receive data + 6 RX- receive data -
Relay outputs (extra code)		
Relays K1, K2, K3 (changeover)	30, 31, 32	
Binary inputs (extra code)		
Supply voltage 24V / 50mA Binary inputs, voltage-controlled LOW = -3 to +5V DC HIGH = 12 to 30V DC	33 6 +24V 5 GND 4 binary input 1 3 binary input 2 2 binary input 3 1 binary input 4	 <p>Example: binary input 4, operated from the internal supply voltage</p>

A

Action (outputs) 73
Active operating mode 23
Alarm 70
Alarm (counter/integrator) 68
Alarm delay 71
Alarm text (counter/integrator) 68
Alter password 101
Analog inputs 64–65, 70–71
Arrange symbols 103
Authorization code 64

B

Basic menu 11, 32
Battery empty 53–54
Baud rate 75

C

Calibration status 76
Cascade 103
CF card code number 63
Channel (counter/integrator) 66
Channel indication 35, 61
Channel line 14, 61, 70
Channel name 70
Channel name (counter/integrator) 67
Channel representation 14, 33, 61
Character entry 55
Character selection 55
Climatic conditions 117
Close 96
Code number 46, 50, 57, 59, 63
Cold junction 64
Color display 11
Commissioning 7
CompactFlash 86
 Errors 52
Computed code No. 64
Configuration
 Analog inputs 64
 Control functions 74
 Counter/integrator 66
 Event traces 66
 Fine calibration 76
 Interface 75
 Meas. storage 70
 Outputs 73
 Texts 74, 76

11 Index

- Connection circuit 64
- Connection diagram 122
- Connection status 80, 103
- Contrast 60
- Control function 74
- Control signal 60, 73
- Control signal (outputs) 73
- Counter 66
- Counter frequency (counters/integrators) 17
- Counter text (counter/integrator) 68
- Counters 17
- Create screen printout 100

D

- Daily end time (counter/integrator) 69
- Daily start time (counter/integrator) 69
- Data
 - Evaluation 27
 - Read-out via interface 27
- Data export to CF card 98
- Data format 75
- Data import from CF card 98
- Data lost 53–54
- Data transfer from device 98
- Data transfer to device 98
- Date 62
- Date and time 100
- Decimal place 70
- Decimal place (counter/integrator) 68
- Default settings 96
- Delete 96
- Device address 75
- Device info 53
- Device name 62
- Device software 54
- Diagram speed 13, 23
- Diagram view 44
- Differential 71
- Digital display 33, 36
- Disconnect 98
- Display 11
- Display off 44
- Display printout 100
- Displays and controls 11

E

- Electrostatic discharge (ESD) 7
- Enable extra codes 99
- Enable options

- Authorization code 64
- Computed code No. 64
- Enable options 64
- Enable program options 98
- End temperature 65
- End time (timed operation) 72
- End value
 - Target 76
- Enter key 11
- Error 54
- Ethernet 28, 75
- Evaluation of measurement data 38
- Evaluation program 50
- Event definition 47
- Event list 47
- Event operation 23
 - Storage cycle 73
 - Stored value 73
- Event traces 15
- Exit 96
- Exit key 11
- Ext. control signal (counter/integrator) 69
- External cold junction temperature 65
- External text 74
- External texts 16

F

- Factory setting 63
- Falling below range 14
- Filter constant 65
- Fine calibration 76
- Function (counter/integrator) 66

G

- Gateway 75

H

- Header 12, 33, 61, 70
- High limit 70
- History 38
- Humidity measurement 106

I

- Import/export errors 87
- Info on setup 104
- Input signal 72

11 Index

Input signal (counter/integrator) 66–67
Installation 117
Installation notes 121
Installation site 117
Integrator 17, 66
Interface type 75
Internal analog inputs 14
IP address 75
IP65 119

K

Key inhibit 74
Keys 10, 12

L

Language 63
Life-cycle data management 24
Limit index 35
Limit value (counter/integrator) 68
Line width 70
Linearization 64
Logic module 22, 105
 Operator priorities 108
Low limit 70

M

Make connection 98
Math module 20, 105
 Operator overview 108
 Operator priorities 108
Meas. range 65
Memory alarm 27, 63
Memory status 72
Memory upload 63
Menu key 11, 32
Modbus flag 84–85

N

New 96
Normal operation 23
 Control signal 73
 Memory status 72
 Storage cycle 72
 Stored value 72
Note signs 9

O

Open 96
Operating modes 23
Operating time counter 18
Outputs 16, 73–74
 Action 73
 Control signal 73
Overrange 14

P

Panel mounting 117
Paper perforations 61
Parameterization 60
Password 45–46, 50, 57, 59, 63
Password activation 101
Password alteration 101–102
PCA3000 20, 27, 64, 113, 116
PCC 27, 86, 91, 113–114, 116
Peak value 40
Period (counter/integrator) 68
Power LED 11
Principle of operation 46
Print 96
Print preview 96
Printer setup 96
Program folder 104
Program options, enabling 98
Protocol 75

R

Range end 65
Rear view 122
Registered license numbers 104
Renew log-in 101
Reporting period (counter/integrator) 18
Representation modes 10
Reset (counter/integrator) 18, 61
Reset counter/int. 63
Reset generation (counter/integrator) 69
Returning 7
RS232/RS485+Ethernet code number 63

S

Save 96
Save as 96
Scaling 35

11 Index

- Scaling end 65–66
- Scaling start 65–66
- Screen off 44
- Screen saver 11, 44, 60
- Screen texts 10
- Scroll operation 38
- Sensor 64
- Sensor monitoring 14
- Setup program
 - Assistant for device settings 91
 - CompactFlash 86
 - Configuration 81
 - Current setup 81
 - Data transfer 86
 - Device list 95
 - Hardware and software requirements 77
 - Installation 78
 - Menu bar 79
 - Menu functions 96
 - Modbus flag 84–85
 - Navigation tree 81
 - Program start 78
 - Shifting the Teleservice window 85
 - Teleservice 80, 84
 - Toolbar 79
 - Toolbar shifting 80
 - Transfer 86
 - User interface 79
 - Working area 80
- Signal type 33–34, 60
- Signal types 15
- Softkey 11–12
- Speed 13
- Speed indic. mode 60
- Standard text 48
- Start temperature 65
- Start time (timed operation) 72
- Start value,
 - Actual 76
 - Target 76
- Status LED 11
- Status line 13
- Status message 52
- Storage cycle 23, 72–73
- Stored value 23, 72–73
- Subnet Mask 75
- Summer time 62
- Supplementary text 48
- Switch-off event 60
- Synchronizing time (counter/integrator) 68

T

Teleservice *103*
Temperature unit *63*
Text entry *55*
Text High alarm *71*
Text Low alarm *71*
Texts *47, 74*
Threshold value (counter/integrator) *67*
Tiled horizontally *103*
Time *62*
Time base (counter/integrator) *67*
Time synchronization *62*
Timed operation *23*
 End time *72*
 Start time *72*
Trace design. *72*
Type (counter/integrator) *66*
Type designation *115*

U

Underrange *14*
Undocumented parameter 1 — 40 *76*
Unit *70*
Unit (counter/integrator) *68*
Unit of measurement *34*

V

Version number *53*
Views *117*

W

Waiting time *60*
Warranty *7*
webserver *28*
Weekday (counter/integrator) *69*
Weighting (counter/integrator) *17, 67*
Window technology *46*
Write interface texts *100*
Writing configuration data to CF card / reading from CF card *51*

Z

Zoom *39*

2008-11-20/00578800

WEST
Control Solutions

Austria T: +43 (0) 2236 691 121
China T: +86 22 8398 8098
France T: +33 (1) 77 80 90 40
Germany T: +49 (0) 561 505 1307
UK T: +44 (0) 1273 606 271
USA T: +1 800 866 6659

Email Inquiries@West-CS.com
Website www.West-CS.com



WEST  **Partlow**
